

# Operating instructions for Vertical adjusting unit EV-800

Original version of the instructions: 01/2017



This document was created by Gühring KG.

All rights on this documentation, in particular the right of copying, distributing and translating the document remain with Gühring KG, also in case of registration of patent rights. No part of this documentation may be reproduced or produced, copied or distributed with electronic media without prior written approval by Gühring KG.



## CONTENTS

<b>1</b>	<b>About these instructions</b>	<b>5</b>
1.1	Read the operating instructions	5
1.2	Applicable documents	5
1.3	Explanation of the general icons	5
1.4	Representation of warning instructions	6
1.4.1	Structure of warning instructions	6
1.4.2	Safety instructions used	7
1.5	Explanation of symbols	7
1.6	Representation of requirements and work instructions	9
1.6.1	Requirements	9
1.6.2	Work instructions with fixed sequence	9
1.6.3	Representation of work instructions	9
<b>2</b>	<b>Identification</b>	<b>10</b>
2.1	Device identification	10
2.2	Manufacturer specifications	10
2.3	Identification plate	10
<b>3</b>	<b>Device description, assembly and function</b>	<b>11</b>
3.1	Proper use	11
3.2	Improper use	11
3.3	Rebuilding and modifications	11
3.4	Technical data EV-800 Comfort Plus	12
3.5	Location conditions	15
3.6	Equipment and accessories	15
3.7	Assembly	15
3.8	Functional description	17
3.9	Safety units	18
3.9.1	General	18
3.9.2	Safety units	19
<b>4</b>	<b>Basic safety instructions</b>	<b>19</b>
4.1	Operator's duty of care	19
4.2	General work safety	20
4.2.1	Staff qualifications	20
4.2.2	Authorised staff	20
4.2.3	Personal protective equipment (PPE)	21
4.3	Basic risks in individual life phases	22
4.3.1	Risks during transport, setup and storage	22
4.3.2	Risks during operation	23
4.3.3	Risks during shutdown and disposal	23
4.4	Device-related risks	24
4.4.1	Risks from electricity	24
4.4.2	Risks of cut injuries	25
4.4.3	Risks of crushing by kinetic energy	25
4.4.4	Penetration hazards	25
4.4.5	Risk of drawing in (rotating spindle on unit)	26



<b>5</b>	<b>Transport, setup and storage</b>	<b>26</b>
5.1	Delivery and packaging	26
5.1.1	Inspection on transport damages	26
5.1.2	Delivery	27
5.1.3	Scope of delivery	28
5.2	Transport	29
5.2.1	Permissible means of transport	29
5.2.2	Transport instructions	30
5.3	Installation	31
5.3.1	Requirements on installation site	31
5.4	Storage	33
<b>6</b>	<b>Operating elements</b>	<b>34</b>
6.1	All versions	34
6.1.1	Display measuring system	34
6.1.2	Operating elements Bearing slide	35
6.1.3	Operating elements Measuring slide	36
6.1.4	Operating elements Centring slide	37
6.2	Only versions EV-800 Basic Plus and EV-800 Comfort Plus	38
6.2.1	Display camera system	38
6.2.2	Crank handle Camera system	39
6.2.3	Power supply unit	40
6.2.4	Fine adjustment Camera system	41
<b>7</b>	<b>Connection and start-up</b>	<b>42</b>
7.1	Inspection of guiding rails	42
7.2	Positioning of single components	43
7.3	Inspection of concentricity and angle error	44
7.4	Connection to power supply system	45
<b>8</b>	<b>Settings</b>	<b>46</b>
8.1	Adjustment of concentricity and angle on exchange adapter	46
<b>9</b>	<b>Operation</b>	<b>51</b>
9.1	Instructions on tools	51
9.2	Switching on	51
9.3	Switching off	53
9.4	Preparing camera system (only on EV-800 Plus versions)	54
9.5	Assembling and preparing a tool	55
9.6	Preparing setting	62
9.6.1	Preparing radial cutting setting (diameter setting)	64
9.6.2	Preparing radial cutting setting (Setting of tapering)	65
9.6.3	Final preparation	66
9.7	Setting of axial side clearance of cutting edge (Only on EV-800-Plus versions)	66
9.8	Radial setting of cutting edge (diameter setting)	67
9.9	Inspection of axial side clearance of cutting edge	70
9.10	Remove tool	70



<b>10</b>	<b>Maintenance and servicing</b>	<b>73</b>
10.1	Measures taken before maintenance and servicing works	74
10.2	Measures taken after maintenance and servicing works	74
10.3	Notes on activities and cycles	74
10.4	Cleaning instructions	74
10.5	Maintenance	75
10.6	Template Maintenance plan	76
10.7	Defects and failures	77
<b>11</b>	<b>Disposal</b>	<b>77</b>
11.1	Disassembly	77
11.2	Proper and environmentally friendly disposal	78
11.3	Disposal facilities	78



## 1 1 About these instructions

### 1.1 Read the operating instructions

Use and handling of the device described below do not come naturally and are explained in the respective technical documentation.

The instructions help you to use the device as intended, properly, effectively and safely.

Thus, read the following chapters thoroughly. If necessary, keep looking up facts that are essential for your operations.

Request new operating instructions if parts have been lost or damaged.

Always keep the instructions in a safe and accessible place close to the device for future reference.



#### Remaining risks

This document gives information and warns you of remaining risks for which the risk reduction by design and protective measures takes no or no complete effect.

### 1.2 Applicable documents

The adjustment unit is supplied with different documents by suppliers. The following documents come with the device and need to be read and observed:

Document
Operating instructions Camera display
Operating instructions Measuring system
Operating instructions LED light

### 1.3 Explanation of general icons

Icon	Explanation
	<b>Important information</b> This icon shows important extra information.
	<b>About this documentation</b> This icon shows that parts of the documentation need to be given special or extra attention, as for example supplier's instructions etc.
	<b>Note on possible property damage</b> This icon shows that a property damage might occur.

Tab. 1: General icons



## 1.4 Representation of warnings

When operating the device there are constantly actions which bear some risks. These actions might be dangerous and are indicated with warnings that precede each action and must be absolutely observed.



### Important information on warnings

Please observe all warnings in this documentation and be particularly careful when taking these actions. Furthermore, please inform all other users accordingly about the warnings.

Warnings (like commands and prohibitions) are for your personal protection!

### 1.4.1 Structure of warnings

The warnings in this document are highlighted with icons and signal words. Icon and signal word show you the severity of the risk.

The warnings that precede all actions are shown as follows:

<b>RISK (1)</b>	
	<b>Type and source of risk (2)</b> Explanation of type and source of risk. (3) ➤ Measures to prevent risk.(4)

The warnings are structured as follows:



Position	Information	Content	Example
1	Level of risk	Severity and classification of risk with signal word and icon	Risk
2	Type and source of risk	What type of risk is it and what is the source?	Risk from electrical current
3	Possible consequences of risk	What will or might happen if the warning is not observed?	When touching conductive parts, this could cause the risk of an electric shock.
4	Measures to prevent or avoid risk	What to do: What not to do: Which protective measures need to be taken?	Works on electrical facilities or plants are to be carried out only by a qualified electrician.



Tab. 2: Structure of warnings





## 1.4.2 Safety instructions used

The following safety instructions are used in this document:

 <b>RISK</b>	
	<b>Indicates an immediate dangerous situation</b> If not avoided, this may cause death or serious injuries.





 <b>WARNING</b>	
	<b>Indicates a dangerous situation</b> If not avoided, this may cause death or serious injuries.

 <b>ATTENTION</b>	
	<b>Indicates a potentially dangerous situation</b> If not avoided, this may cause light or minor injuries.

<b>NOTE</b>	
	<b>Indicates a potentially harmful situation</b> If not avoided, this may cause damage to the system or any object in the surrounding area

## 1.5 Explanation of symbols







Warning symbols indicate dangerous areas, risks and obstacles.

Warning symbols	Explanation
	Indicates dangerous area
	Indicates electrical current
	Indicates risk of crushing
	Indicates risk of cutting

Tab. 3: Warning symbol used





Command symbols provide effective accident prevention at workplace.

Command symbol	Explanation
	General command symbol
	Wear safety helmet
	Wear hair net
	Wear safety shoes
	Wear protective gloves
	Disconnect main plug

Tab. 4: Command symbols used

Prohibition symbols increase safety

Prohibition symbol	Explanation
	General prohibition symbol
	Unit must be operated only by one person
	Water spraying prohibited

Tab. 5: Prohibition symbol used





## 1.6 Representation of requirements and operating instructions

### 1.6.1 Requirements

If certain requirements are mandatory in order to carry out a certain action, they are indicated and represented in the text with a checkbox.

Example Requirement

...

- The thread is coated with holder lubricant

### 1.6.2 Operating instructions in a fixed order

For many actions taken on the device it is absolutely mandatory to carry out the working steps in a fixed order.

These steps are given operating instructions and have consecutive numbers. In addition, the operating instructions provide intermediate and final results. Intermediate results represent processes which are not run by the user and are marked by an arrowhead ▶. End results indicate the end of the action and are marked with a tick ✓.

The order of the working steps needs to be absolutely maintained and operating instructions must be observed under all conditions.

Example Operating instructions in fixed order

1. Switch on unit at main switch
  - ▶ The control system of the unit boots
2. Start the Software
  - ▶ The Software starts and the following screen appears:
  - ✓ Unit and software are ready for use

### 1.6.3 Representation of operating instructions

Operating instructions that can be carried out in any order, are listed in bullet points and marked by arrowheads.

Operating instructions are mandatory and need to be observed.

#### Expl. Operating instruction

...

- Wear suitable protective gloves.
- Remove oil from the tool.



## 2 Identification

### 2.1 Device identification

Device designation Adjusting unit EV800 Tool type: Adjusting unit Equipment number, see identification plate Year of construction, see identification plate  
Equipment number, see identification plate  
Year of construction, see identification plate

### 2.2 Manufacturer data

#### Main Headquarters

Gühring KG

Herderstr. 50-54

72458 Albstadt

Germany

Phone +49 7431 17-0

Fax +49 7431 17-21279

E-Mail [info@guehring.de](mailto:info@guehring.de)

Internet [www.guehring.de](http://www.guehring.de)

### 2.3 Identification plate

The device is clearly marked by the identification plate.



Fig. 1: Identification plate

1	Type designation	3	Year of construction
2	Construction no. / Device number	4	Gühring logo



## **3 Device description, assembly and function**

### **3.1 Proper use**

The device is only intended for proper use as described in this documentation. It is an operating tool that has been designed for commercial use in the industrial sector.

The adjusting unit EV-800 is exclusively to be used to adjust single or multi-edged tools with guiding and reference rails by Gühring. Also the adjustment of concentricity and angle errors on modular tool systems by Gühring, as well as the inspection and analysis of tools and edges in the specified supports falls under proper use.

### **3.2 Improper use**

The device is not intended to be used for any other purpose than the proper use described in this document.

Basically any other use than the proper use is to be considered as improper use. Otherwise, safe operation can no longer be guaranteed. The operator and not the manufacturer will be liable for any damages or harm caused to persons or objects due to improper use.

### **3.3 Rebuilding and modifications**

Rebuilding and modifications made to the device are only permissible in agreement with the manufacturer.

If non-original spare parts are used, any resulting consequences will invalidate any liability of the manufacturer. Always use specified spare parts. This applies in particular to safety-related components.



## 3.4 Technical data EV-800 Komfort Plus

<b>Electrical connection</b>	<b>Value</b>	<b>Unit</b>
Rated voltage	230	V
Power input	3	A
Network	1L+N+PE / 60 Hz	

<b>Dimensions and weight</b>	<b>Value</b>	<b>Unit</b>
Total mass	120	kg
Footprint	430 x 400	mm
Height	1410	mm

<b>Criteria of tool to be tested</b>	<b>Value</b>	<b>Unit</b>
Max. diameter	130	mm
Max. length	800	mm
Max. weight	20	kg
Cutting edge	HSK-25 to HSK-100, between tips	

<b>Colour design</b>		
Basic colour	Graphite black	RAL 9011
Other components	„Gühring-Yellow“	RAL 1023

Equipment on version EV-800 Comfort Plus in accordance with low-voltage directive 2006/95/EC

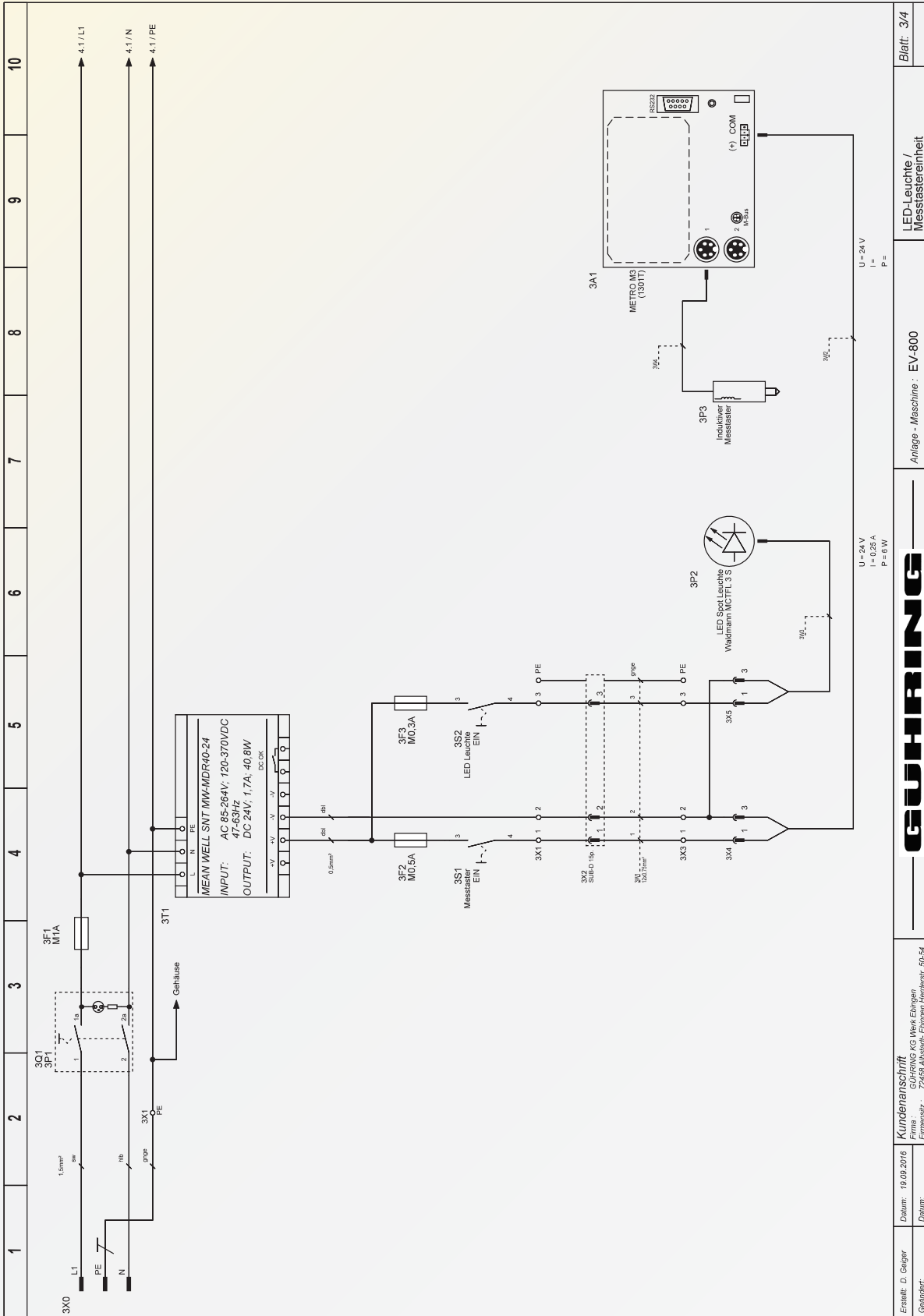

Fig. 2: Circuit diagram LED light / Measuring probe unit

Erstellt: D. Geiger	Datum: 19.09.2016	Kundenanschrift: GÜHRING KG Werk Ebingen Firmenstr.: 72459 Abstatt-Ebingen, Heidenstr. 50-54	LED-Leuchte / Messastereinheit	Blatt: 3/4
Geändert:	Datum:	Firmenstr.:	Anlage - Maschine - EV-800	

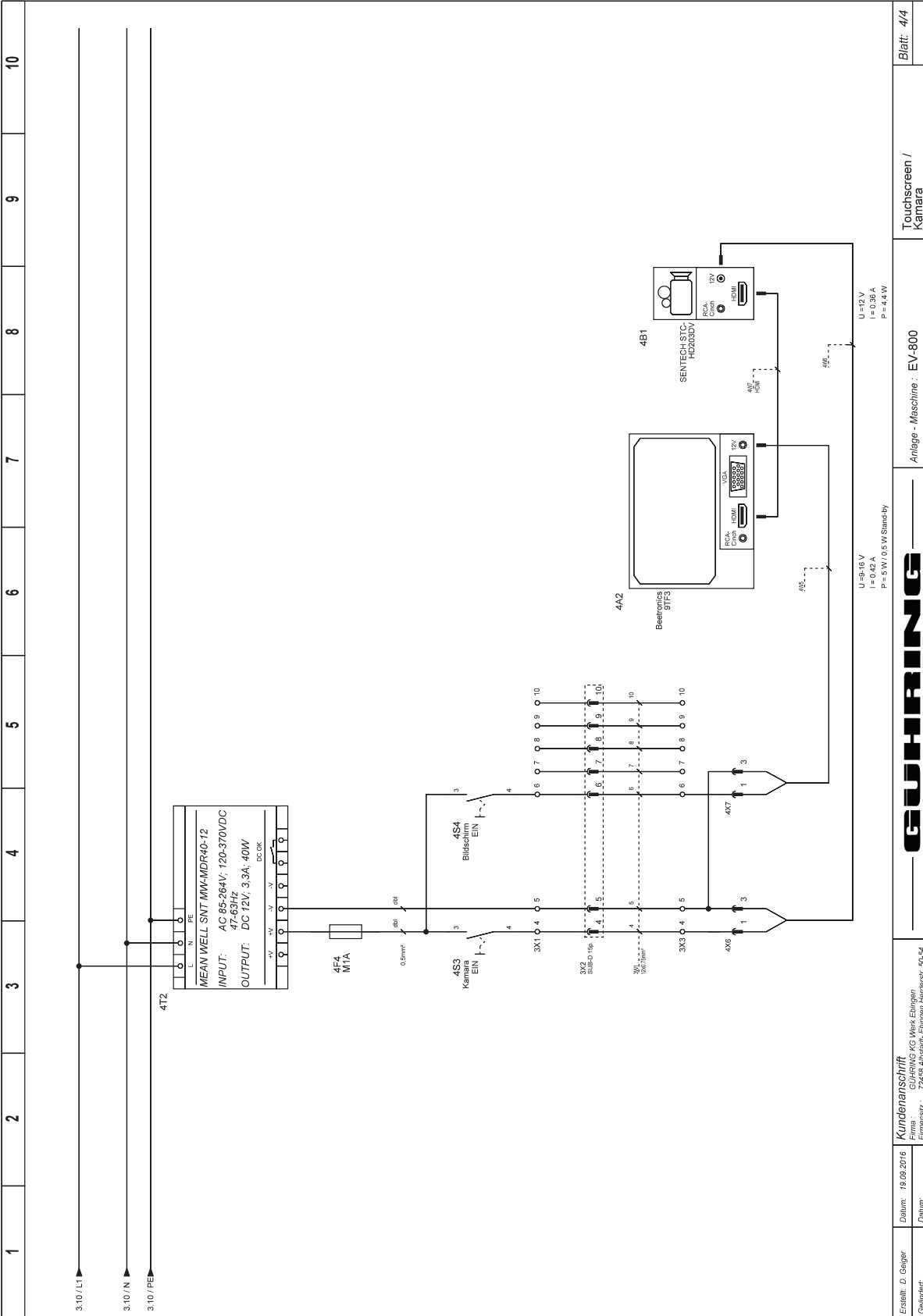

Fig. 3: Circuit diagram Touchscreen / Camera

Erstellt: D. Geiger	Datum: 18.08.2016	Kundenschrift: GÜHRING KG Werk Ebingen	Anlage - Maschine - EV-800	Touchscreen / Kamera	Blatt: 4/4
Geändert:	Datum:	Firmensitz: 72458 Albstadt-Ebingen, Herberstr. 50-54			



## 3.5 Location conditions

To ensure smooth operation of the device, the following location and installation conditions must be given.

Ambient conditions	Value	Unit
Operation temperature	20 ± 2	°C
Temperature range for storage and transport	+10 bis +40	°C
Air humidity	max. 60	%

### Weight

The floor/table on which the device is installed must be even and horizontal. In addition, it must be suitable for a load of min. 150 kg.

### Space requirements

The space required needs to be specified according to the „Technical data“ (chapter 3.4). It needs to be made sure that the operating and working area is taken into consideration.

## 3.6 Equipment and accessories

The adjusting unit comes with different equipments and components. The scope of delivery and accessories depend on the equipment requested. There are different equipments available:

Designation	Equipment and accessories	Article number
EV-800 Basic	Base frame with fixed tip	333181062
EV-800 Basic Plus	Base frame with fixed tip and camera assembly group	333181063
EV-800 Komfort	Base frame with spindle kit and adaptor flange (standard HSK63)	333181064
EV-800 Komfort Plus	Base frame with spindle kit, adaptor flange (standard HSK63) and camera assembly group	333181065

## 3.7 Assembly

The adjusting unit comes with different equipments and components. Regarding functionality there is a difference between the components with and without camera assembly group. In the following both versions are described.



## EV-800 Basic and EV-800 Komfort

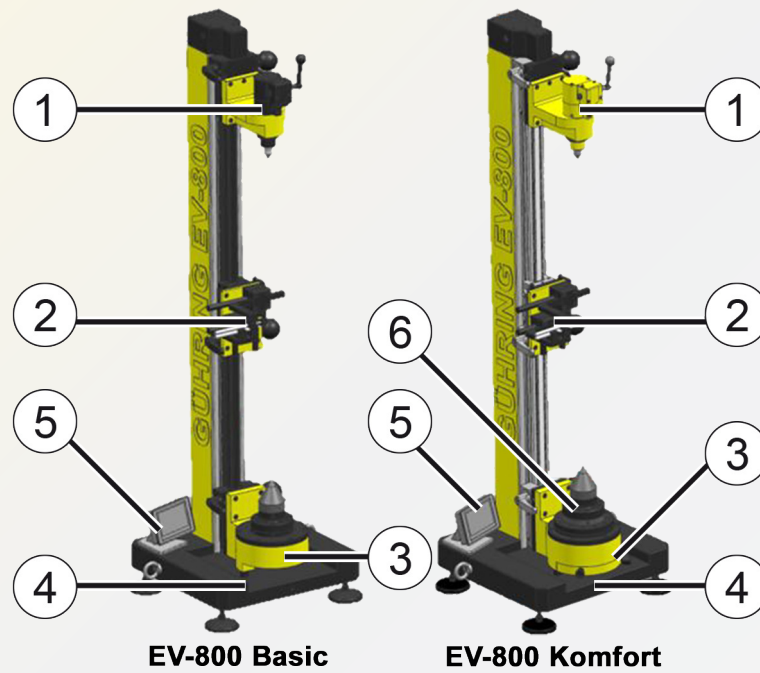

Fig. 4: EV-800 Basic and EV-800 Komfort

1	vertically adjustable slide with spring-loaded heel	3	vertically adjustable bearing slide	5	Display of measuring system
2	vertically adjustable measuring slide	4	Base frame	6	HSK exchange spindle





## EV-800 Basic Plus and EV-800 Komfort Plus

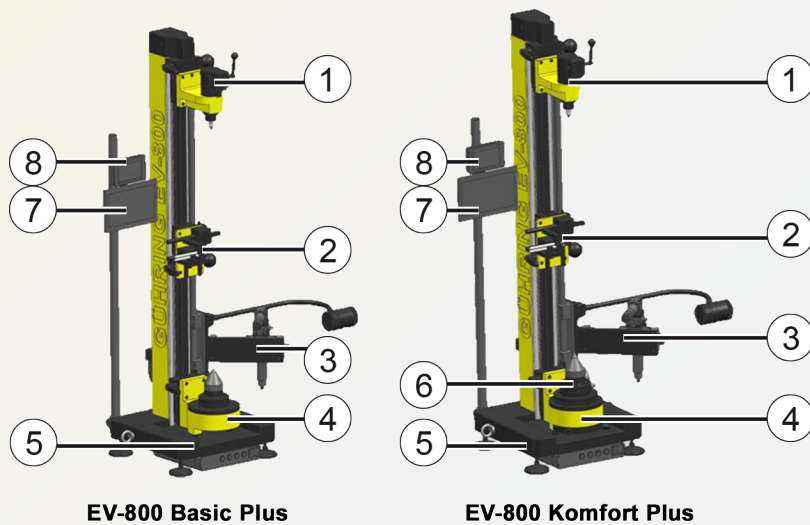

Fig. 5: EV-800 Basic Plus and EV-800 Komfort Plus

1	vertically adjustable slide with spring-loaded heel	3	vertically adjustable camera assembly group with LED light	5	Base frame	7	Display for camera system
2	vertically adjustable measuring slide	4	vertically adjustable bearing slide	6	HSK exchange spindle	8	Display of measuring system

### 3.8 Functional description

Cleaning of HSK cutting edge. The tool is assembled into the HSK exchange spindle on the vertically adjustable bearing slide. Then the tool is approached by the measuring slide and concentricity checked. The values measured appear then on the display of the measuring system.

After adjustment and inspection, the tool is clamped with the heel by means of the vertical slide.

The tool clamped can be adjusted and checked.

The tool is then removed from the adjusting unit.

The vertical slides and the exchange spindle enable to measure, adjust and check different tool types and lengths.

Furthermore, both versions EV-800 Basic Plus and EV-800 Komfort Plus have a camera system with LED light and an additional camera display. Due to the camera system inspection and analytic works on the tool and axial adjustment of the edges can be carried out



## 3.9 Safety units



### 3.9.1 General

The safety units of the device serve to protect the staff against dangers caused by the device, which has been constructed in accordance with applicable statutory provisions and which is reliable in operation.

Constructional dangerous spots that can not be excluded are equipped with a protective unit and, if necessary, marked with warning signs on the tool and instructions on work safety are provided in the operating instructions.

The device must only be operated if all safety units and safety-related items are available and functional.

 <b>RISK</b>	
	<p><b>Risk during disassembly or manipulation of safety units</b></p> <p>Disassembling or manipulating safety units can cause severe and irreversible, even fatal injuries or death, or cause adverse health effects or significant damage to property.</p> <ul style="list-style-type: none"><li>➤ Do not disassemble any safety units</li><li>➤ Do not manipulate any safety units</li><li>➤ Inspect all existing safety units at regular intervals</li></ul>

 <b>WARNING</b>	
	<p><b>Risk of accident through absent or defective safety units</b></p> <p>Unauthorised modifications made to the safety units, may cause injuries to the body.</p> <ul style="list-style-type: none"><li>➤ Check the safety units on proper function before operation and replace defective safety units, if need be</li><li>➤ Do not modify any safety units</li></ul>



## 3.9.2 Safety units

The device has the following safety/protective units.

Safety units	Operation and result
vertically adjustable and tiltable displays	The display can be tilted and adjusted according to ergonomic regulations. This helps to prevent bad postures at work.
vertically adjustable measuring slide and camera system	The measuring slide and camera system can be adjusted in their height according to ergonomic provisions. This helps to prevent bad posture at work.
Counterweight for easy handling	An integrated mechanical fall arrester on the measuring slide prevents the slide from falling down and appendages from being crushed when the locking brake is loosened.
Spindle housing	The spindle is equipped with housings to lower the risk of long hair being drawn when turning the spindle
adjustable LED light	To make sure that the tool is sufficiently lighted and to improve visual tool identification an LED light has been installed. Strain on eyes is reduced.

## 4 Basic safety instructions

There will always be remaining risks caused through use in general, even if the tool is properly used and the safety instructions observed. They cannot be prevented through constructional measures and need to be observed carefully. Please read this chapter thoroughly.

### 4.1 Operator's duty of care



#### Important information

The device has been planned, constructed and designed based on provisions, directives and standards, risk assessment and further technical specifications. Therefore, it meets the technical requirements and guarantees maximum safety.

Safety in operational practice can only be achieved if all necessary measures are taken. It is the operator's duty of care to plan these measures and to make sure that they are taken.

As the tool is used on a commercial basis, the operator is committed to work safety. These operating instructions need to come with safety instructions and accident prevention provisions, environmental protection regulations as well must be observed.



#### Important Information

It is the operator's duty to make sure that the operating instructions are read and understood by his staff.



#### Important Information

The device is used in combination with other tools. Therefore, all notes and instructions on these tools need to be read and observed.



### Technical state of device

The device's technical state needs to meet the following requirements and must be guaranteed by the operator:

- The device must be used properly.
- Prior to each operation process, the device needs to be checked on its perfect technical state.
- No unauthorised modifications, manipulations and changes to the device must be done.
- The device must be serviced and checked within specified time intervals.
- The operating instructions need to be always available in complete readable condition and has to be accessible at the place of operation.

## 4.2 General work safety

### 4.2.1 Staff qualification

#### Important information on staff qualification

All activities around the device must only be done by trained, qualified and authorised persons.

<b>⚠ WARNING</b>	
	<p><b>Risk caused by staff inadequately qualified</b></p> <p>There is a risk of heavy injuries and considerable property damage, if unqualified staff is in the device danger zone or runs works on the device.</p> <ul style="list-style-type: none"> <li>➤ All activities with the device must only be run by qualified staff.</li> <li>➤ Keep unqualified staff away from the danger zone.</li> </ul>

### 4.2.2 Authorised staff

Designation	Definition
Qualified person	<p>Based on these instructions a qualified person is a person which is trained and qualified in metal cutting. Alternatively, qualifications requested to run the device, could also be gained through many years of professional experience in similar fields. In addition, this person should be experienced in the field of cutting tools, the tools used and the respective processes.</p> <p>A qualified person also has know-how of relevant standards and regulations. This person should be able to assess assigned work tasks and independently recognise possible risks based on his or her work experience and qualifications.</p>

Tab. 5: Staff qualification



Phase of life/Chapter	Staff qualification
Transport, setup and storage	Qualified person
Connection and start-up	Qualified person
Operation	Qualified person
Settings	Qualified person
Maintenance and servicing	Qualified person
Disposal	Qualified person

Tab. 6: Authorised staff

## 4.2.3

### Personal protective equipment (PPE)



#### Important information on personal protective equipment

When running works on the device, the staff must wear suitable PPE. Please note the following list and the instructions in the work area regarding personal protective equipment.



#### Personal protective equipment (PPE)

The grade of the protective equipment needs to be evaluated and defined for each individual case.

See the following for PPE recommended:



#### Wear safety shoes

The safety shoes are supposed to protect feet against heavy toppling or falling objects, as well as against slipping on slick ground.



#### Wear protective gloves

The protective gloves are supposed to protect hands against frictions, abrasions, stabs and deep-cut injuries, as well as against contact with hot surfaces or liquids.



#### Wear head/hair protection

Head/hair protection is a hairnet, a cap or a hat, a hair ribbon or any other object to cover or tie long and loose hair. It serves to protect long hair from getting stuck or drawn in by mobile (ex: also rotating) device components



## 4.3 Basic risks in each life phase

### 4.3.1 Risks during transport, setup and storage



#### Transport



During loading and transporting works, only lifting tools, lifting accessories and suitable transport vehicles with sufficient lifting capacity must be used. In addition, transportation locks must be attached to avoid unintentional change in position (tilting, turning etc.).

Use the protective equipment that complies with the provisions and make sure there is sufficient space for maneuvering to prevent persons from getting injured or from colliding with objects. The adjusting unit is assembled and is delivered with the appropriate settings. It must not be disassembled. Therefore, it needs to be transported by suitable means of transport.

#### Transport by crane

If the adjusting unit is transported suspended, the following needs to be observed.

 <b>RISK</b>	
 	<p><b>Risk of suspending load</b></p> <p>If the device is transported suspended by crane or fork lift, it could provoke uncontrolled movements if not secured properly, which might cause light or heavy body injuries or even death.</p> <ul style="list-style-type: none"><li>➤ Never stay under a crane transporting suspending load or device!</li><li>➤ Make sure that no loose objects, tools or components are attached on or on top of the device as they may fall off the crane during transport.</li></ul>

 <b>RISK</b>	
 	<p><b>Risk of defective lifting accessories</b></p> <p>If the lifting accessories (chains, ropes etc.) are damaged, there might occur dangers during transport by crane.</p> <ul style="list-style-type: none"><li>➤ Always carry out a visual inspection before using lifting accessories and check them on their safe condition</li><li>➤ Prevent ropes and lifting belts from rubbing on sharp edges and angles</li><li>➤ Screw in hooks and eye bolts completely</li><li>➤ Damaged or bent hooks and eye bolts must not be repaired or used, but must be dispose</li><li>➤ Only use lifting accessories for lifting purposes, which are suitable to lift the respective weight</li><li>➤ Only use the lifting accessories mentioned in chapter Transport</li></ul>



## **ATTENTION**



### **Risk of sudden unexpected movements during lifting process**

There is a risk of injury through sudden movements during lifting process

- Always pay attention to the device during the lifting process
- Make sure that no persons are in the danger zone

### **Set-up**

When setting up the device, please refer to chapter „Location conditions.

### **Storage**

If the device is supposed to be stored, please refer to chapters „Technical data“ and „Location conditions“ and the device must be prepared appropriately.

## **4.3.2 Dangers during operation**

To run operating works, the user needs to be instructed and trained by the operator every year. The obligation to proof the instruction/training lies by the operator. Working without prior instruction is not authorised.

Any risky or unsafe work procedure must be omitted. Only use the device properly.

## **WARNING**



### **Injuries caused through improper and unexpected operation**

Injuries to the body can be caused through improper and unexpected operation of the device.

- Check the safety units before using the device
- Only operate the tool if in proper condition
- Only operate the device alone. There will be a higher risk of injuries the more people operate the tool

## **4.3.3 Risks during shutdown and disposal**

The adjusting unit has a high empty weight. Therefore, please observe the safety instructions during each transport in chapter „Risks during transport, set-up and storage“.

### **Disassembly**

For a simple shutdown and disposal the tool can be disassembled into single components.

### **Shutdown and disposal**

A safe disposal that meets all national and international regulations of operating funds, as well as spare parts and auxiliary materials needs to be guaranteed.





## 4.4 Device related risks

### 4.4.1 Risks caused by electrical power

Only qualified electricians must connect the device to the power supply and run works on the electrical components, as well as in the switch cabinet taking into consideration the respective standards and directives.

The electrical device equipment is to be checked on a regular basis. Defects, like loose connection, damaged or frayed cables, need to be removed right away.

In case of interferences in electrical power supply the device needs to be switched off immediately.

 <b>RISK</b>	
	<p><b>Risk during work on live device parts</b></p> <p>When running works on the device you might touch parts which carry dangerous voltages. Touching live parts can cause death.</p> <ul style="list-style-type: none"><li>➤ Works on electrical plants/operating funds must be carried out only by qualified electricians or by persons who are instructed and observed by qualified electricians in accordance with the electrotechnical regulations</li><li>➤ The safety regulations for running works on electrical plants and operating funds must be observed</li></ul>



### Disconnect main plug

Before starting work on live parts disconnect main plug and separate the device from power supply.

Please observe the following safety regulations to run works on electrical plants/operating funds:



1. Disconnect!
2. Protect against switching on again!
3. Make sure device is disconnected from voltage!
4. Earth and short-circuit!
5. Close and isolate live parts in the near!





## 4.4.2 Risks of cut injuries

The tools to be set have sharp cutting edges due to their purpose of use.

 <b>ATTENTION</b>	
	<p><b>Risk of cutting by sharp cutting edges</b> If not properly used sharp cutting edges might cause cut injuries on upper appendages.</p> <ul style="list-style-type: none"><li>➤ Do not touch the cutting edges</li><li>➤ Watch out for the sharp cutting edges when using the tool</li><li>➤ Wear suitable protective gloves</li></ul>





### Wear protective gloves

Wear suitable protective gloves when working on the tools.



## 4.4.3 Risks of crushing caused by kinetic energy

The slides on the linear guidings move downwards by their empty weight if the fixing brake is loosened and might cause crushing injuries to appendages caused by kinetic energy though all safety precautions were taken.

 <b>ATTENTION</b>	
	<p><b>Danger of crushing by slides moving downwards</b> The slides on the linear guidings move downwards if the fixing brake is loosened and might crush appendages which are underneath.</p> <ul style="list-style-type: none"><li>➤ Carefully secure the slide with the fixing brakes.</li><li>➤ Only loosen the fixing brakes, if there are no appendages underneath.</li></ul>

## 4.4.4 Risks from stabs

The centring tip might cause stabs on fingers and hands, if it is loosened unintentionally or if it moves downwards, while appendages are between tool and centring tip.

 <b>ATTENTION</b>	
	<p><b>Stab injuries caused by centring tip</b> If the pretension is loosened, the centring tip moves towards the tool. Appendages between tool and centring tip are stabbed due to the pretension of the centring tip.</p> <ul style="list-style-type: none"><li>➤ Please work very carefully when operating the centring tip.</li><li>➤ Operate the tool alone. This prevents unintentional loosening/ movements by third persons</li></ul>



## 4.4.5 Risk of drawing in (rotating spindle on tool)

The spindle is turned slowly by the user. When turning long hair or wide clothes can be drawn in.

<b>⚠ ATTENTION</b>	
	<p><b>Risk of drawing in on device</b></p> <p>There is a risk of drawing in wide clothes, personal jewelry, scarves, neckerchiefs etc, long hair or gloves This may cause light to heavy injuries to the head, as for example shortage of breath caused by choking, abrasion, injuries to the skin etc..</p> <ul style="list-style-type: none"><li>➤ Do not wear wide close</li><li>➤ Do not wear personal jewelry, like necklaces or bracelets</li><li>➤ Do not wear a tie</li><li>➤ Do not wear gloves which have not been approved by the operator</li></ul>



### **Wear head protection, like a hair net, cap, hair ribbon**

Long hair should be protected with a hair net, a cap or a hair ribbon to prevent it from being drawn into the device.

## 5

## Transport, setup and storage



### **Staff qualification**

The following staff is authorised for „Transport and storage“:

- Staff with relevant professional experience and specialised skills in operating the device
- All electrical works around the device must only be done by trained, qualified and authorised qualified electricians.



### **Important information for your safety**

It lies in your responsibility!

In any case the safety instructions in chapter „Basic safety instructions“ and the local safety regulations must be observed and followed.

## 5.1 Delivery and packaging

### 5.1.1 Inspection on transport damages

Check the device on transport damages when delivered. If there are any transport damages, please inform the manufacturer right away. It is recommended to take pictures of the damages.



## 5.1.2 Delivery

The adjusting unit is delivered in a wooden box and is fastened to the floor of the box by means of tension straps. The box should be stored for storage or transport purposes at a later point of time.

For protection against corrosion the adjusting unit is oiled when being delivered. The adjusting unit should be cleaned before being used for the first time.



Fig. 6: Delivery

If the packaging is not required to be stored for later use, e.g. maintenance, storage or return, please dispose it environmentally friendly.



### **Important information**

Immediately contact Gühring KG, if the adjusting unit has not been delivered properly in the wooden box. It might be damaged if not transported properly.



**To unpack the unit proceed as follows:**

1. Open the cover of the wooden box by removing the 6 torx screws
  2. Put the cover aside.
  3. Carefully loosen the two tension straps.
  4. Remove all packaging and take out the device and its accessories
    - ▶ Take into consideration the high weight of the unit!
  5. Check the scope of delivery by means of the delivery note and the documents enclosed.
    - ▶ If there are any deviations regarding the scope of delivery, immediately contact the manufacturer. If not, the shipment is considered as being complete and accepted.
  6. Compare the data on the identification plate with the data on the delivery note and your order.
    - ▶ If there are any deviations regarding the scope of delivery, immediately contact the manufacturer. If not, the shipment is considered as being complete and accepted.
- ✓ The device is unpacked and can be transported to the place of installation.

### 5.1.3 Scope of delivery

The scope of delivery is different and depends on the equipment version. The scope of delivery comprises.

- Operating instructions and maintenance plan
- Adjusting unit EV-800
- HSK-63 module adapter (standard)
- Camera incl. distance ring and lens (only on EV-800 Plus version)
- Measuring system with two inductive measuring probes and special measuring tips
- Display (only on EV-800-Plus versions)
- Mains cable (only on EV-800-Plus versions)
- LED light (only on EV-800 Plus versions)



## 5.2 Transport

### 5.2.1 Permissible means of transport

The device must be transported with permissible means of transport. The base plate of the device has 3 mounting points for eye bolts (1) or other attachment points.

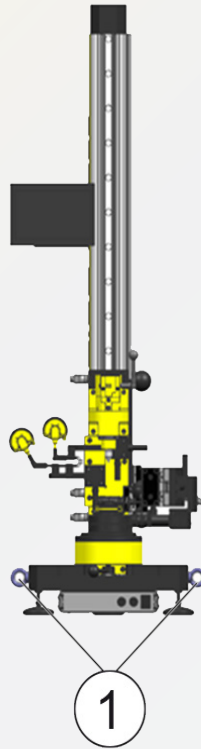

Fig. 7: Mounting points (1) for eye bolts

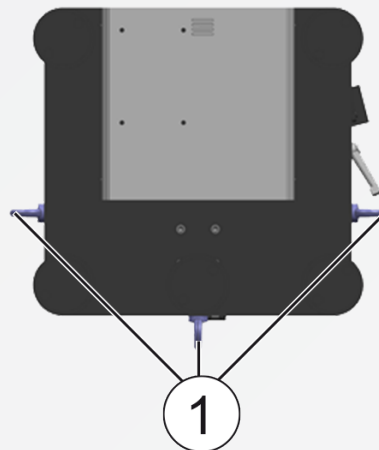









Fig. 8: View from bottom: Mounting points (1) for eye bolts

Transport can be carried out with the following means of transport and transport equipment:

- Transport by means of lifting device (like a fork lift)
- Transport by crane (incl. ropes and chains)



## 5.2.2 Transport instructions

 <b>RISK</b>	
 	<p><b>Risk of suspending load</b></p> <p>If the device is transported suspended by crane or fork lift, it could provoke uncontrolled movements if not secured properly, which might cause light or heavy body injuries or even death.</p> <ul style="list-style-type: none"><li>➤ Never stay under a crane transporting suspending load or device!</li><li>➤ Make sure that no loose objects, tools or components are attached on or on top of the device as they may fall off the crane during transport</li></ul>
 <b>RISK</b>	
 	<p><b>Risk of defective lifting accessories</b></p> <p>If the lifting accessories (chains, ropes etc.) are damaged, there might occur dangers during transport by crane.</p> <ul style="list-style-type: none"><li>➤ Always carry out a visual inspection before using lifting accessories and check them on their safe condition.</li><li>➤ Prevent ropes and lifting belts from rubbing on sharp edges and angles</li><li>➤ Screw in hooks and eye bolts completely.</li><li>➤ Damaged or bent hooks and eye bolts must not be repaired or used, but must be disposed.</li><li>➤ Only use lifting accessories for lifting purposes, which are suitable to lift the respective weight.</li><li>➤ Only use the lifting accessories mentioned in chapter Transport.</li></ul>
 <b>ATTENTION</b>	
	<p><b>Risk of sudden unexpected movements during lifting process</b></p> <p>There is a risk of injury through sudden movements during lifting process.</p> <ul style="list-style-type: none"><li>➤ Always pay attention to the device during the lifting process</li><li>➤ Make sure that no persons are in the danger zone</li></ul>

Note on transport:

- Check if all guiding slides are in the lowest position of the guiding rail.
- For transport screw the ring screws into the M10 tapped holes of the base.
- The operator needs to be authorised to guide the hoists with which the device is to be transported.
- Before the device is lifted, all persons need to get out of the work area of the hoist.
- Ropes or chains used for transport must not be damaged and need to provide the respective lifting capacity.
- Ropes and chains must not get into contact with the device while being lifted. They must be suspended only at the holder points provided.



## 5.3 Installation

### 5.3.1 Requirements on installation site

The adjusting unit requires a suitable ambient with appropriate conditions.



#### Important information for smooth operation

To ensure that the device operates smoothly, the following location and installation conditions must be observed.

### WARNING



#### Risk of crushing by falling device

If the subsoil (e.g. table) does not meet the tool requirements, it may be damaged or destroyed and the device may fall down/over. Appendages might be crushed by the weight.

- Please make sure that the subsoil provides the suitable capacity for the device's weight.

### NOTE



#### Measuring errors or property damage through unsuitable installation environment

If the installation environment does not meet all requirements, measuring errors or damages to the tool may be the consequence.

- Always make sure that all requirements are met.

#### Requirements on installations site:

- Clean and proper surface of 500 x 500 mm size
- Room temperature at 20 +/- 2°C
- suitable subsoil (e.g. table) with a load capacity of min. 150 kg
- Air humidity max. 60%



**To install the adjusting unit, please proceed as follows:**

1. Remove the packaging of the adjusting unit.

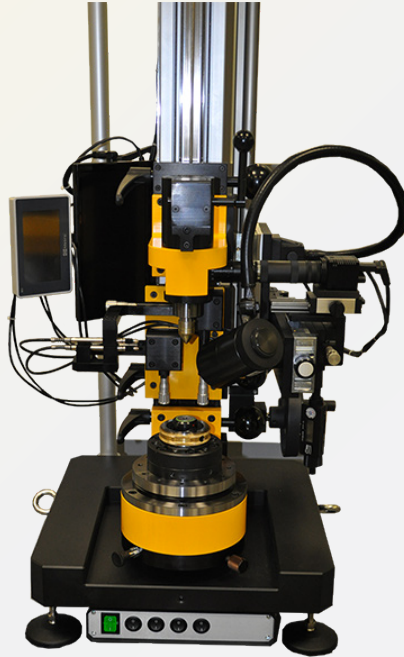

Fig. 9: Transport position

2. Check if all guide carriages are secured and in lowest position (this is the transport position).
  - ▶ If the locking device of one or more guide carriages has loosened, secure it again to avoid the guides from being damaged during installation.
3. Lift and move the adjusting unit by means of ring bolts or a crane to the desired spot.
4. Remove the ring bolts and store them in the transport box.
  - ✓ The adjusting unit is installed and start-up can be started.





## 5.4 Storage

The following points need to be observed to guarantee that the device that is not in operation for a longer period of time, remains functional:

NOTE	
	<p><b>Property damages caused through inappropriate storage conditions</b></p> <p>If not all storage requirements are met, the tool might be damaged. Damages might possibly not be visible from the outside.</p> <p>➤ Always make sure that all requirements are met.</p>

### Storage requirements:

- Temperature between +10°C and +40°C
- Air humidity max. 60%
- The storage area must be clean and dry
- The device must be installed on an even ground to prevent it from being distorted
- The device must be secured against tilting
- The device must be covered completely to prevent dirt and dust from getting inside.
- The device must be protected against frost, humidity and rain.



### Note on storage

To store the device, use the wooden box in which the tool was delivered.



## 6 Operating elements

### 6.1 All versions

In the following all operating elements and their function are described, which are available on all versions of the adjusting unit EV-800.

#### 6.1.1 Display Measuring system

The display of the measuring system is attached on the left side of the foot and indicates the measuring results during operation. On versions EV-800 Basic Plus and EV-800 Comfort Plus it is attached above the camera display on the vertical height adjustment.

It is switched on with a button on the back or with a power supply unit (with EV-800 Basic Plus and EV-800 Comfort Plus).



Fig. 10: Display Measuring system

Number	Operating element
1	Display Measuring system



#### Important information in supplier's documentation

See the respective instructions for further information on how to work with the measuring system display.



## 6.1.2 Operating elements Bearing slide

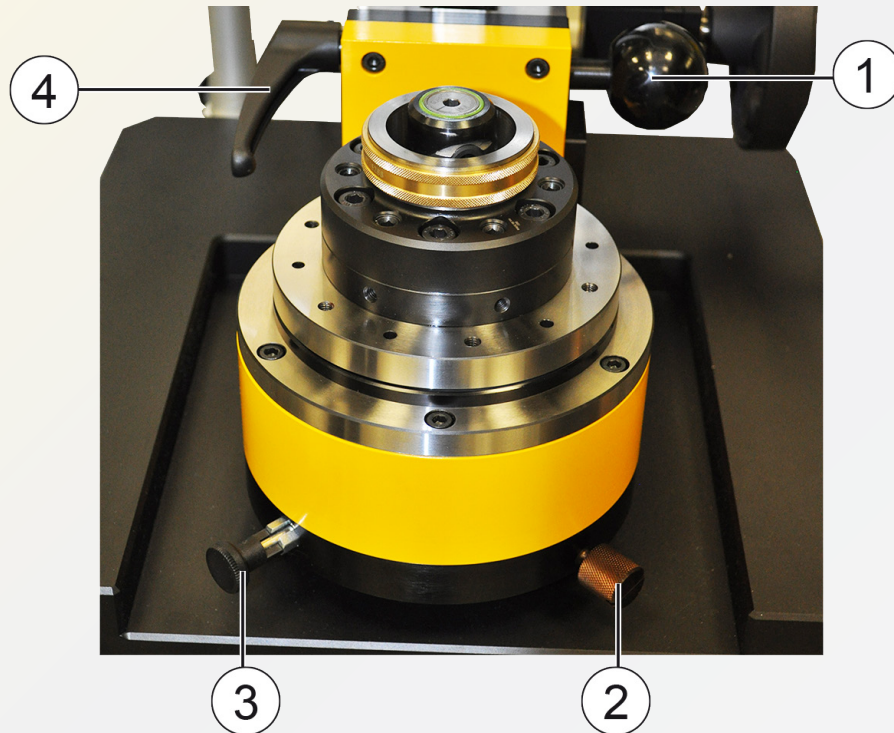

Fig. 11: Operating elements bearing slide

Number	Operating element
1	Handle for height adjusting bearing slide
2	Screw to tighten/loosen brake for HSK spindle
3	Turning handle to lock/loosen HSK spindle
4	Lever to tighten/loosen the vertical height adjustment of the bearing slide



## 6.1.3 Operating elements Measuring slide

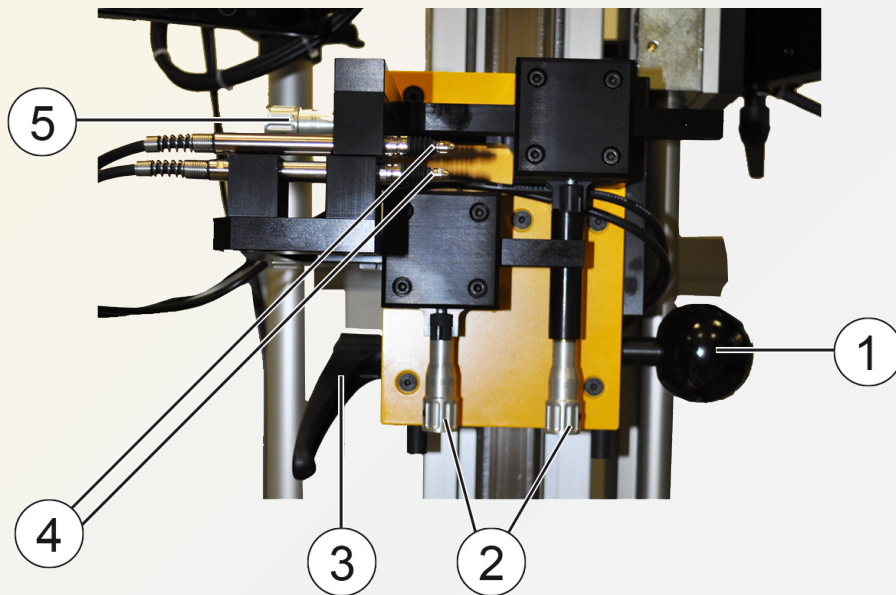

Fig. 12: Operating elements measuring slide

Number	Operating element
1	Handle for vertical height adjustment of measuring slide
2	Thimble for fine adjustment of horizontal measuring probes
3	Lever to tighten/loosen height adjustment of measuring slide
4	Measuring tips
5	Thimble for fine adjustment of vertical measuring probes



## 6.1.4 Operating elements Centring slide

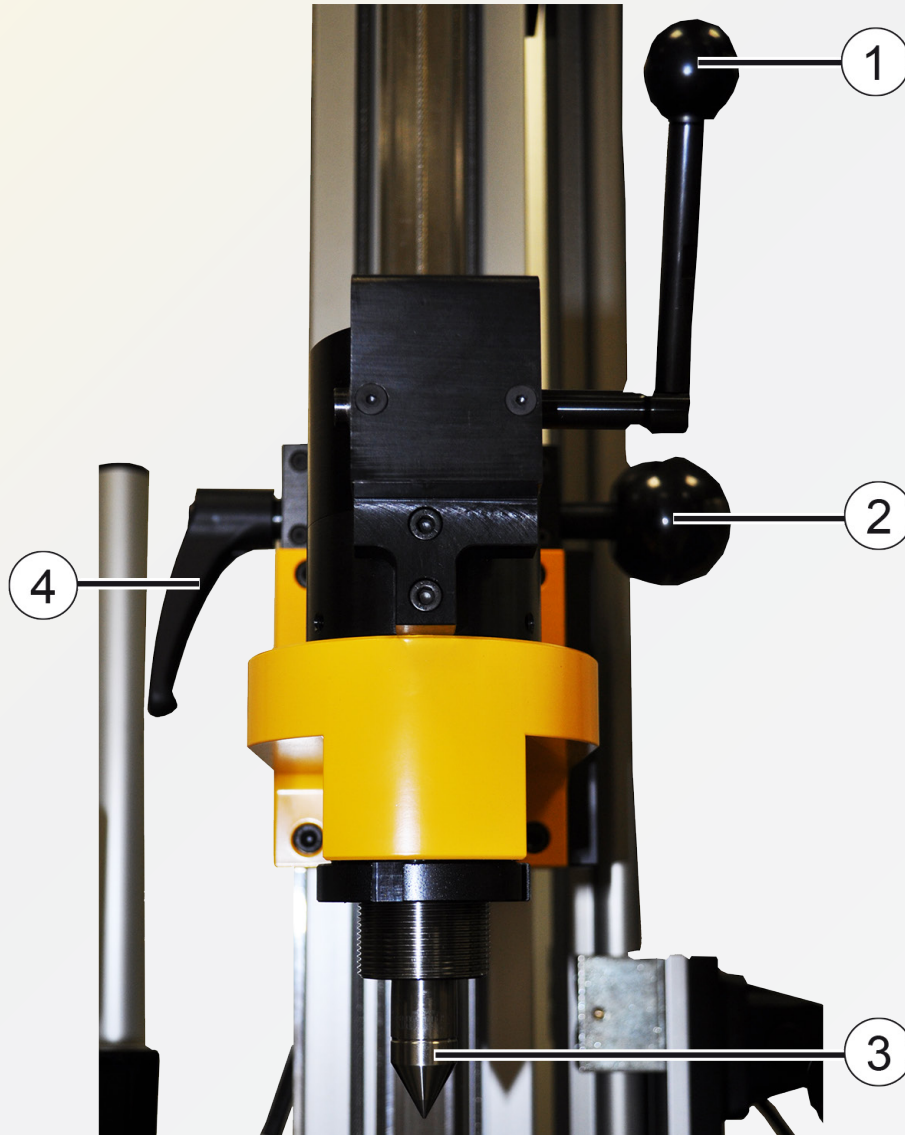

Fig. 13: Operating elements centering slide

Number	Operating element
1	Lever to lift/lower heel
2	Handle for vertical height adjustment of slide
3	Heel MK2
4	Lever to tighten/loosen vertical height adjustment of slide



## 6.2 Only version EV-800 Basic Plus and EV-800 Comfort Plus

In the following all the operating elements and their functions of versions EV-800 Basic Plus and EV-800 Comfort Plus are described.

### 6.2.1 Display Camera system



Fig. 14: Operating element Display camera system

Number	Operatting element
1	Display camera system



#### Important information in supplier's documentation

See the respective instructions for further information on how to work with the display of the camera system.



## 6.2.2 Crank handle Camera system

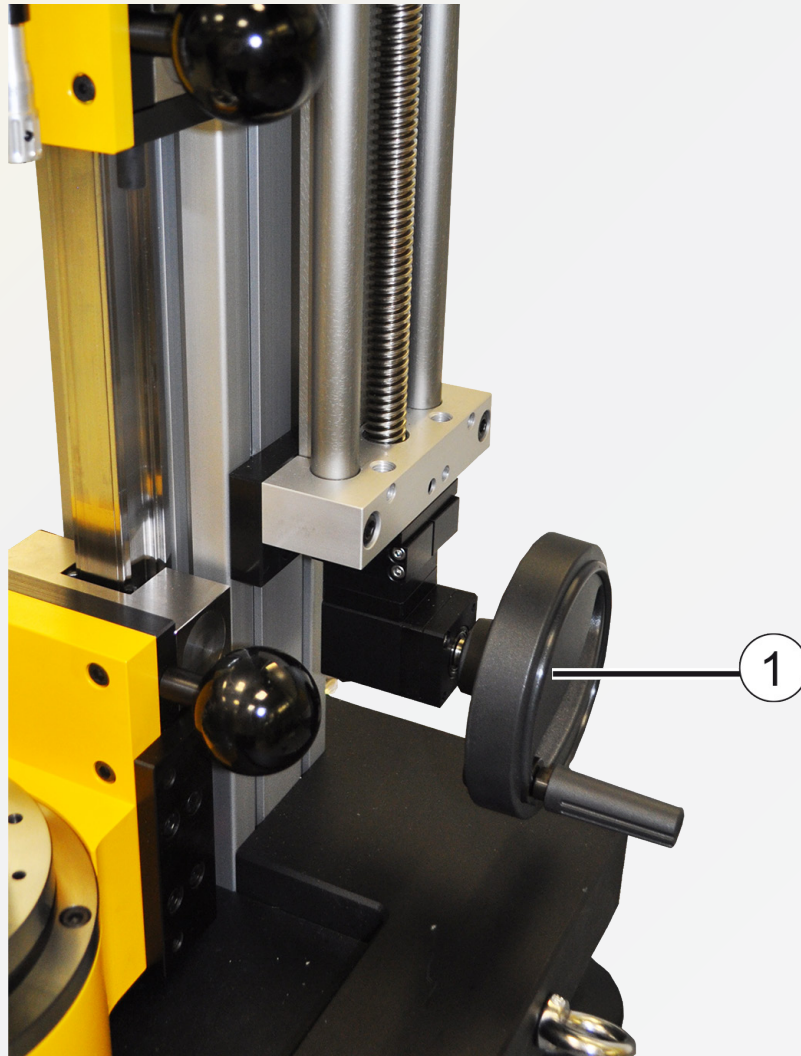

Fig. 15: Operating elements Crank handle Camera system

Number	Operating element
1	Hand crankle to lift/lower complete camera wing



## 6.2.3 Power supply unit

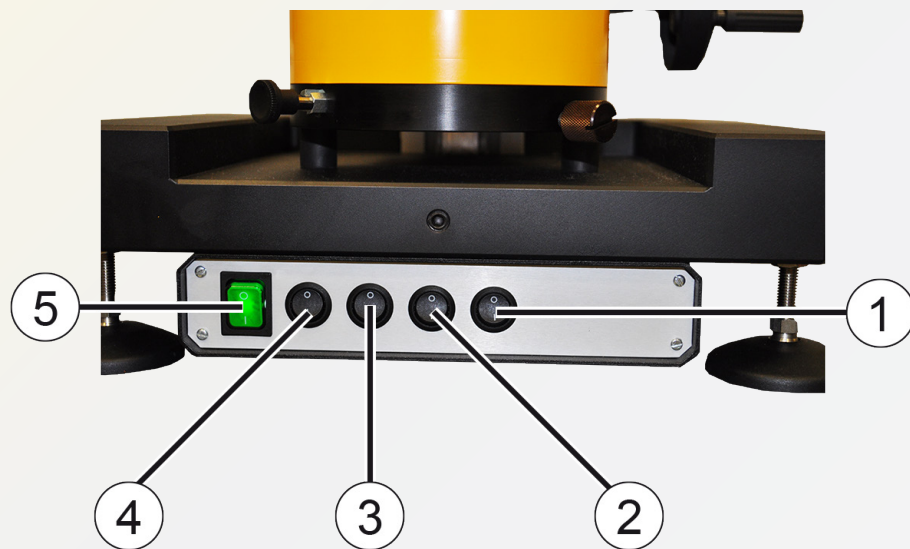

Fig. 16: Operating elements Power supply unit

Number	Operating element
1	Switch on/switch off display camera system
2	Switch on/switch off camera system
3	Switch on/switch off LED light
4	Switch on/switch off display measuring system
5	Main switch





## 6.2.4 Fine adjustment Camera system

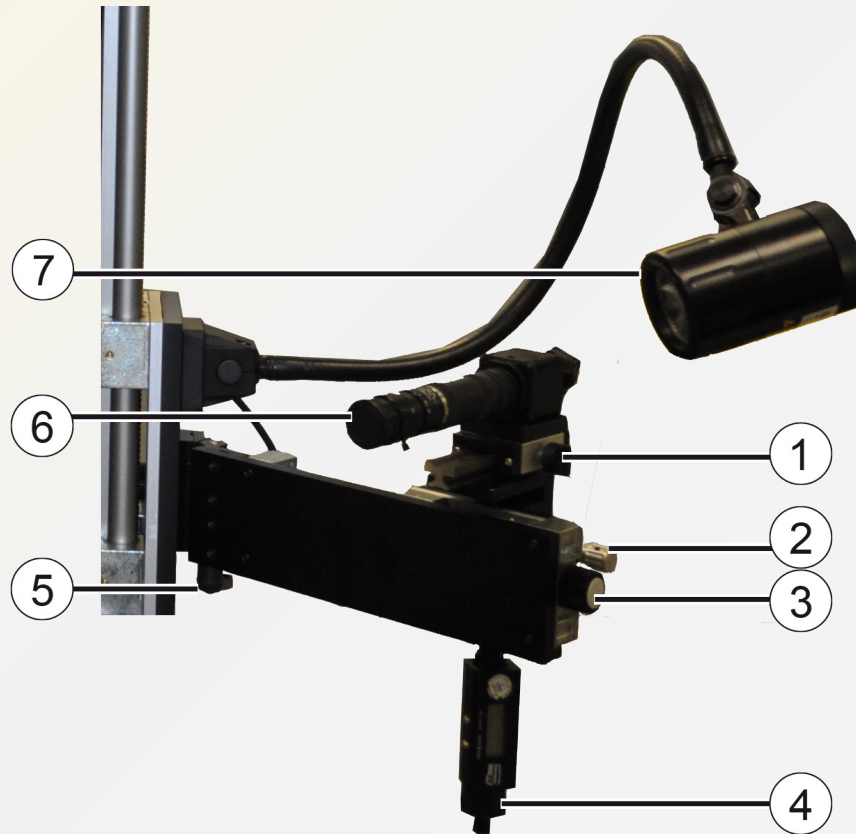

Fig. 17: Operating elements Fine adjustment Camera system

Number	Operating element
1	Rough adjustment camera slide with locking screw
2	Thimble for horizontal fine adjustment of camera
3	Thimble for horizontal rough adjustment of camera
4	Thimble for vertical fine adjustment of camera
5	Lever to tighten/loosen lateral adjustment of camera system
6	Camera lens for focusing object (fine adjustment)
7	LED light



## 7 Connection and Start-up



### Staff qualification

The following staff is authorised to carry out „Connection and start-up“:

- Staff with relevant professional experience and specialised skills in operating the device
- All electrical works around the device must only be done by trained, qualified and authorised qualified electricians



### Important information for your safety

It lies in your responsibility!

In any case the safety instructions in chapter „Basic safety instructions“ and the local safety regulations must be observed and followed In any case the safety instructions in chapter „Basic safety instructions“ and the local safety regulations must be observed and followed.

### 7.1 Inspection of guiding rails

After the adjusting unit is installed, the guiding rails need to be checked on their function.

#### Requirements:

- Chapter „Set-up“ must have been carried out
- Please pay attention to chapter „Lubricants“

#### To check the guiding rails, please proceed as follows:

1. Move the swivel arm with the camera backwards.
  - ▶ The guiding carriage is now easier to access.
2. Clean all guiding units (1) with a cloth

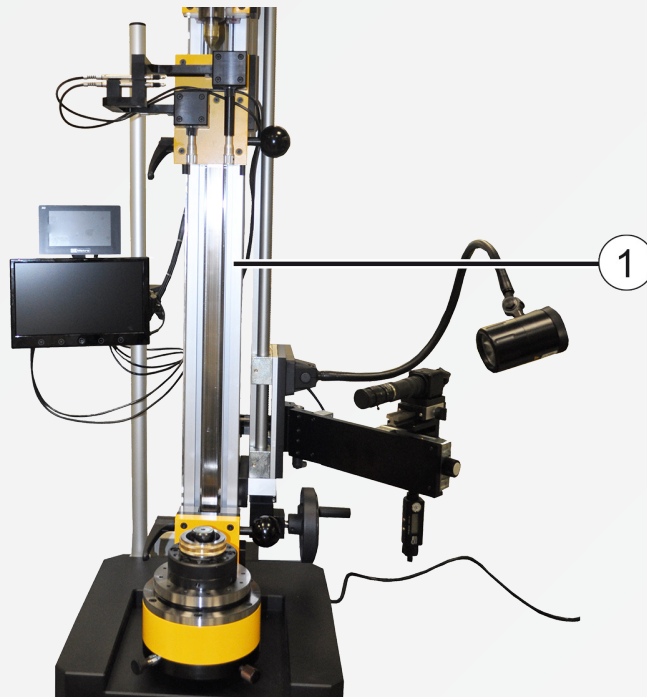

Fig. 18: Cleaning guiding units



3. Lubricate the guiding units and apply the lubricants all-over the guiding units by moving the guiding carriages over the complete guiding distance.
  - ✓ If the guiding units are rough-running or stuck, the lubricating nipples on the slides need to be re-lubricated. If the problem still exists, please contact the service at Gühring.
  - ✓ The guiding rails have been checked.

## 7.2 Positioning of single components

Before starting-up the adjusting unit single components need to be positioned. They are in transport position to prevent transport damages.

The following single components need to be positioned:

- Display of measuring system and display
- Camera wing
- Measuring slide
- Centring slide



Fig. 19: Completely positioned adjusting unit



## 7.3 Inspection of concentricity and Angle error



### Important information

The concentricity and angle error of the adjusting unit is calibrated and set before delivery. Before starting operation it must only be inspected to avoid measuring errors.



### Important information

Wait at least 5 hours after set-up to have the adjusting unit adapted to the room temperature. If the adjusting unit has not acclimatised (20 +/- 2°C) measuring errors may be the consequence.

### Requirements:

- Adjusting unit acclimatised to room temperature
- Test pin HSK 63 (separately available)
- Calibrated measuring probe  $\mu\text{m}$  division on stand

1. To check the concentricity and angle error of the HSK holder, please proceed as follows:  
Clamp the test pin into the HSK adapter by means of the provided torque.



Fig. 20: Tighten test pin



2. Fasten a stand with a dial gauge at an appropriate place and check the concentricity at its lowest and upper position (angle error) of test pin
  3. Concentricity and angle error should be max. 5  $\mu\text{m}$ .
  4. If concentricity or the angle error exceed the values given, for re-adjustment please proceed as described under „Set-up“.
- ✓ Check completed.



## 7.4 Connection to power supply system

Check if the power supply available matches with the voltage described in the operating instructions on the type plate (see also chapter „Technical Data“).

For operation the adjusting unit must be connected to the power supply system.

 <b>RISK</b>	
	<p><b>Risk of electric shock by damaged mains plugs</b></p> <p>When touching damaged mains plugs, you might get in contact with parts conducting dangerous voltages. Touching live parts can cause death.</p> <ul style="list-style-type: none"><li>➤ Before connecting to the power supply check the mains plug on damages</li><li>➤ Immediately replace damaged mains plugs</li><li>➤ Never operate the adjusting unit if the mains plug is damaged</li><li>➤ The safety regulations to run works on electrical plants and operating funds must be observed</li></ul>

### Requirements:

- Instructions in chapter „Inspection of guiding rails“ need to be observed
- Instructions in chapter „Positioning of single components“ need to be observed
- Instructions in chapter „Inspection of concentricity and angle error“ need to be observed

To connect the device to the mains supply, proceed as follows:

1. Connect mains cable to adjusting unit.
  2. Connect mains cable to power supply.
- ✓ The unit has been connected to the power supply and is ready for operation.



## 8 Settings



### **Staff qualification (only EV-800 Comfort versions with HSK module adapter)**

The following staff is authorised to make „Settings“:

- Staff with relevant professional experience and specialised skills in operating the adjusting unit and the appropriate tools to be set.



### **Important information for your safety**

It lies in your responsibility!

In any case the safety instructions in chapter „Basic safety instructions“ and the local safety regulations must be observed and followed.

## 8.1 Adjustment of concentricity and angle on Exchange adapter



### **Adjustment of concentricity on exchange adapter**

#### **Important information on adjustment of concentricity**

The adjusting unit comes ex works and is equipped with an adjusted HSK 63 spindle.

Warning: The spindle assembled must be checked at regular intervals and adjusted, if necessary.

Re-adjustment should only be done by trained and qualified staff.

Before setting the exchange adapter the sharpened surfaces (circular + axial run-out) on the spindle should be checked. This helps to troubleshoot a bearing run-out error which is corrected by means of the exchange adapter by taking the following steps listed.

1. Fasten dial gauge with stand at appropriate place of unit.
2. Position dial gauge on outer surface and turn the spindle to troubleshoot the concentricity error on the spindle
3. Position dial gauge at appropriate place of upper plane surface to troubleshoot the axial run-out error
  - ▶ After that the exchange adapter system can be mounted

#### **Requirements:**

- Torque wrench (approx. 5 - 40 Nm) with hexagonal inserts 3, 4, 5 and 6
- Hexagon socket wrench of size 3 ,4 ,5 and 6
- Calibrated measuring probe  $\mu\text{m}$  division on stand
- Test pin GM300, article no. 4971

To make the concentricity adjustment on the exchange adapter, please proceed as follows:

1. Take the tool out of its holder
2. Clean the HSK cone thoroughly.



3. Insert the test pin into the spindle and tighten it with the provided torque wrench (18 Nm on HSK-63).

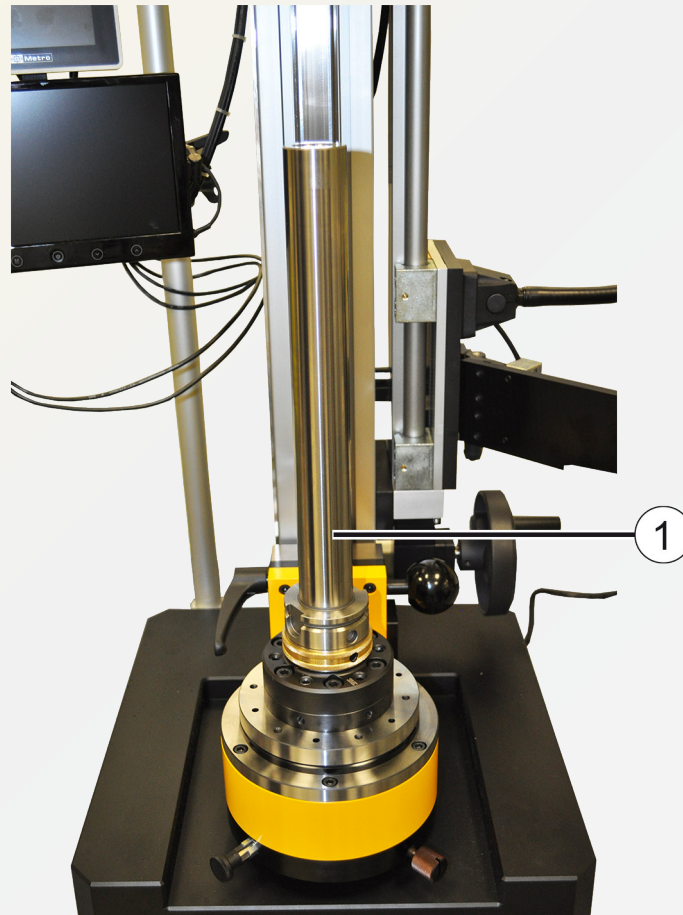

Fig. 21: Insert test pin

4. Loosen all axial and radial screws of size 3, 5 and 6 using hexagon socket wrenches.

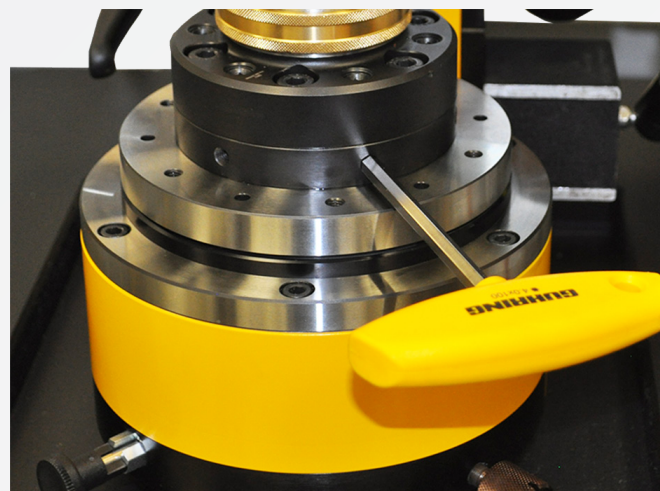

Fig. 22: Loosen screws



5. Position the dial gauge at a very low and sharpened position of the test pin. Take the highest point of measurement and „reset“ the dial gauge.

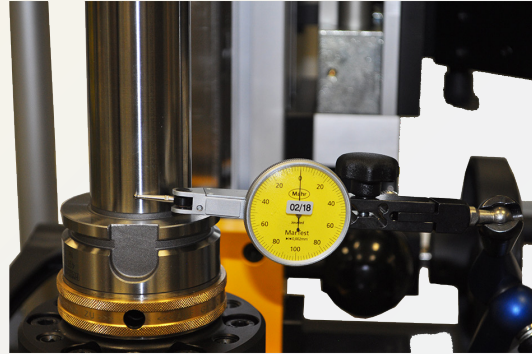

Fig. 23: Position dial gauge and reset

6. Roughly adjust the concentricity of the exchange adapter by means of the adjusting screws (2) (threaded pin, size 3) (approx. 0.01 mm).
7. Slightly tighten the 6 fastening screws (1) (approx. 50% of tightening torque, see table 1 „Tightening torques“ for details)

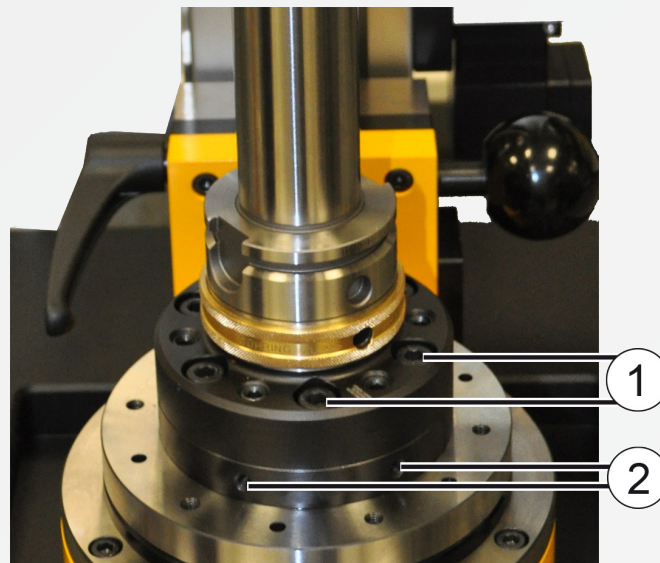

Fig. 24: Fastening screws (1) or adjusting screws (2)

8. Adjust the concentricity of the holder to approx. 5  $\mu\text{m}$  by means of the adjusting screws (2). Loosen the adjusting screws (2) every time by at least by half a turn.
9. Apply all adjusting screws (2) with slight pressure.





10. Tighten the 6 axial fastening screws (1) with the provided torque wrench

Module-Ø	Fastening screw	Torque wrench
60	DIN 912-5x16-12,9	8,7 Nm
70	DIN 912-6x20-12,9	15 Nm
80	DIN 912-6x20-12,9	15 Nm
100	DIN 912-8x25-12,9	32 Nm
117	DIN 912-8x25-12,9	32 Nm
140	DIN 912-10x30-12,9	72 Nm

Tab. 1 Torque wrench

11. Repeat this procedure until the concentricity error is  $\leq 3\mu\text{m}$ .

12. Slightly apply all radial adjusting screws (2) and check concentricity again.

13. Remove the dial gauge.

✓ Concentricity adjustment on the exchange adapter is completed



#### Important information on test pin

The test pin is not part of the scope of delivery. Suitable test pins can be found in our catalogue (GM300, article no. 4971).

To run the angle adjustment on the exchange adapter, please proceed as follows. If a test pin has already been installed, please continue with step 3.

1. Clean the HSK cone and the planar support of the test pin cone carefully
2. Install the test pin (1) for HSK over the  $L=300\text{ mm}$ .
3. Place the measuring probe at the tip and „reset“ the dial gauge.

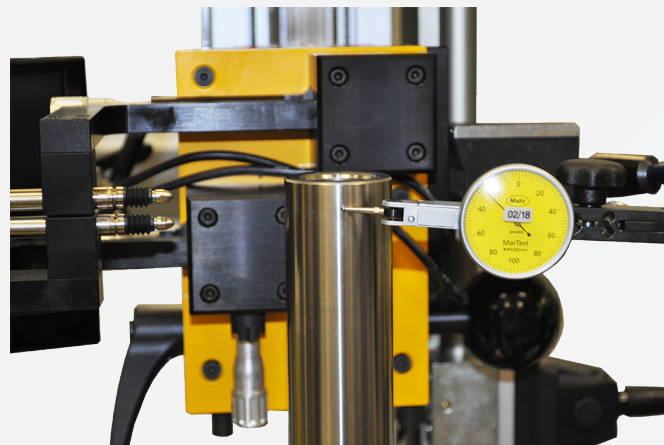

Fig. 25: Place measuring probe

4. Check the angle error by turning the spindle.
5. Approach the position with the highest peak and mark it.



6. Correct the angle error by means of the adjusting screws. Only one adjusting screw should be used near the marked spot.



### Important information

Mark all tighten screws used for adjustment.

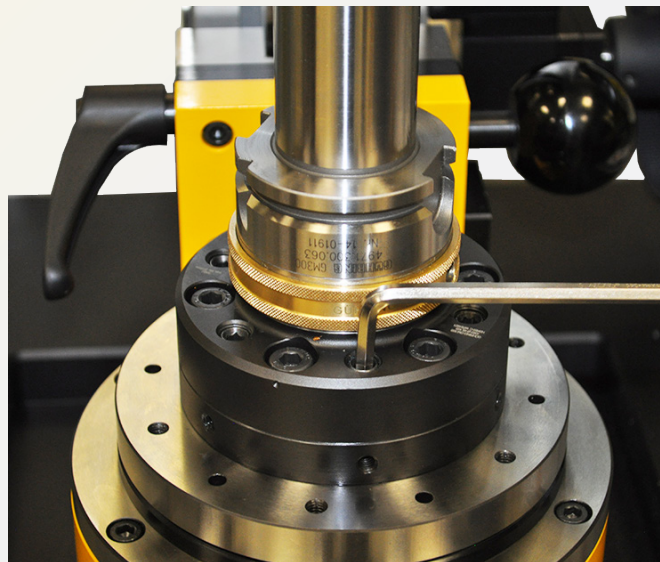

Fig. 26: Tighten adjusting screws

3. Slightly apply all non-clamped axial adjusting screws.

4. Remove the dial gauge and the stand.

- ▶ If the radial adjustment at the lower part of the test pin is to be adjusted, the angle adjustment as well needs to be adjusted
- ✓ The angle adjustment on the exchange adapter is completed.



## 9 Operation

### Staff qualification

The following staff is authorised for „Operation“:

- Staff with relevant professional experience and specialised skills in operating the device
- All electrical works around the device must only be done by trained, qualified and authorised qualified electricians.



### Important information for your safety

It lies in your responsibility!

In any case the safety instructions in chapter „Basic safety instructions“ and the local safety regulations must be observed and followed.

<b>⚠ WARNING</b>	
	<p><b>Injuries caused through improper and unexpected operation</b></p> <p>Injuries to the body can be caused through improper and unexpected operation of the device.</p> <ul style="list-style-type: none"><li>➤ Only operate the device properly and if in good order and condition</li><li>➤ Only operate the tool yourself</li></ul>

### 9.1 Instructions on Tools

Make sure that the tools to be measured are dry and do not contain any remnants of cooling lubricant.



### Important information on measuring results

Before setting soiled tools need to be cleaned. If not measuring results can be influenced.

### 9.2 Switching on

For each version, the adjusting unit EV-800 must be switched on in different ways.

To switch on the EV-800 Basic or EV-800 Comfort, proceed as follows:

1. Set up the power supply by means of the supplied USB cable and plug adapter for the USB cable and a plug socket.
2. Push the button on the back of the measuring system display.
  - ▶ The measuring system starts booting.
  - ✓ The adjusting unit is ready for operation as soon as the measuring system has booted.

To switch on the EV-800 Basic Plus and EV-800 Comfort Plus, proceed as follows:

1. Set up the power supply via the mains plug.



2. Push green main switch (1) at the power supply unit.

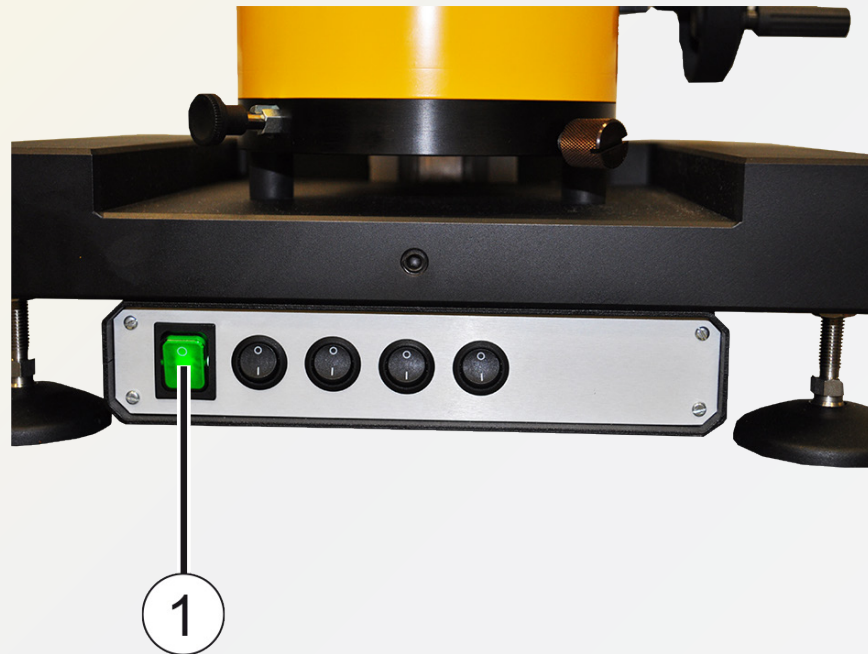

Fig. 27: Push main switch

3. Push the switches for the measuring system (2).

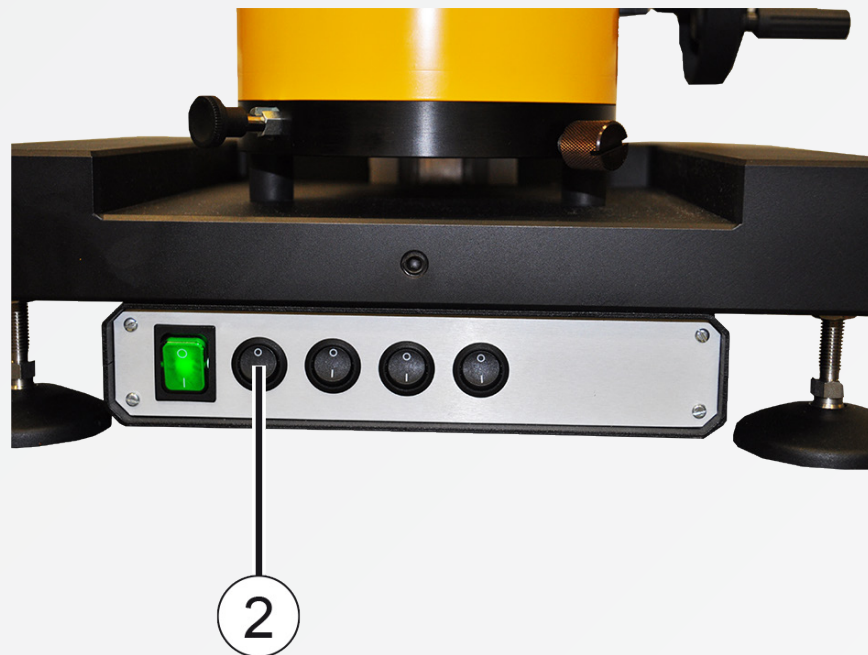

Fig. 28: Start measuring system

▶ The measuring system starts booting



4. Push the following switches, if need be: LED light (3), camera (4) and display (5).

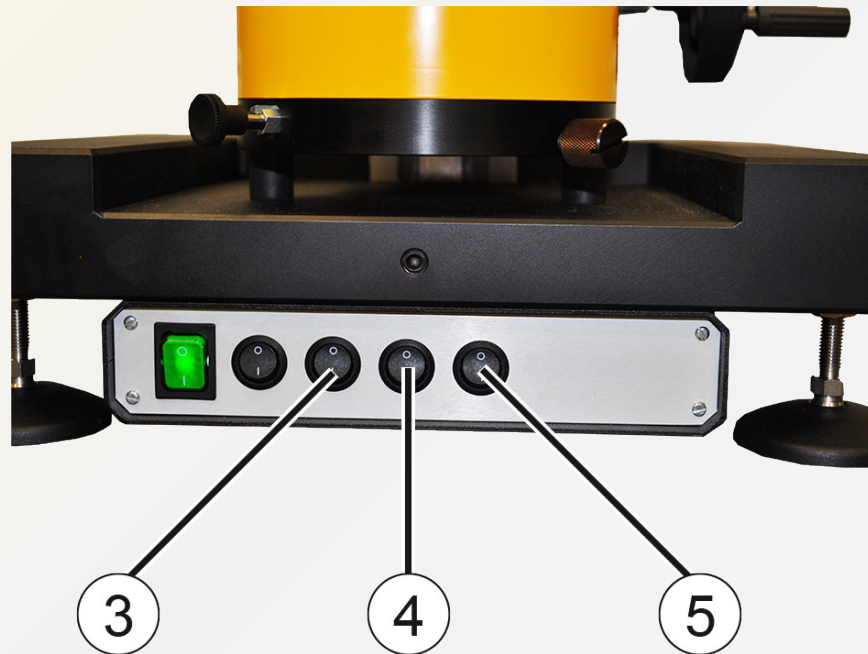

Fig. 29: : LED light, switch on camera and display

- ✓ The adjusting unit is ready for operation as soon as the measuring system has booted.

### 9.3 Switching off

For each version the adjusting unit EV-800 must be switched off in different ways.

To switch off the EV-800 Basic or EV-800 Comfort, proceed as follows:

1. Switch off the measuring system by using the button on the back of the display.
  2. Unplug the unit.
- ✓ The adjusting unit is switched off.



To switch off the EV-800 Basic Plus or EV-800 Comfort Plus, proceed as follows:

1. Push the green main switch (1) on the power supply unit.



Fig. 30: Push main switch

- ✓ The adjusting unit is separated from the power supply and switched off.  
Unplug the device if not operated for a long time

## 9.4 Preparing camera system (only for EV-800 Plus versions)

To prepare the camera system, please proceed as follows:

1. Position the camera at height of centring tip.
  2. Adjust the light according to the centring tip.
  3. Make sure that the object focusing is positioned in central position
  4. Rough focusing of tip by means of slide for rough camera focusing.
  5. Clamp slide to rough camera focusing.
  6. Final focusing via camera setting (see illustration 31)
- ✓ Preparation of camera system completed. Now start setting the axial side clearance of the cutting edge.

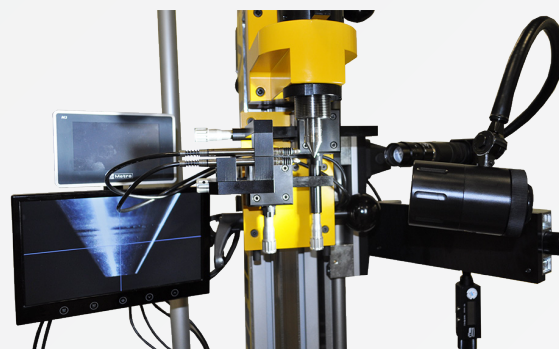

Fig. 31: Adjust camera wing



## 9.5 Assembling and preparing a Tool

Before a tool can be set, the unit needs to be prepared.

### Requirements:

- ☑ Torque wrench (approx. 5- 40 Nm) with the suitable hexagonal inserts for HSK clamping
- ☑ Tool with ground centres
- ☑ Optional: Tool with HSK (63) adapter to mount spindle
- ☑ Optional: HSK 63 adapter with tip

In order to install the tool and prepare it for setting, proceed as follows:

1. Clean the tool and the holder thoroughly.
2. Loosen the clamps on the spindle (1) and set the height roughly to make sure that the tool can be well observed. Please note the ergonomic regulations provided by your company. Basically the spindle slide remains in its basic position.

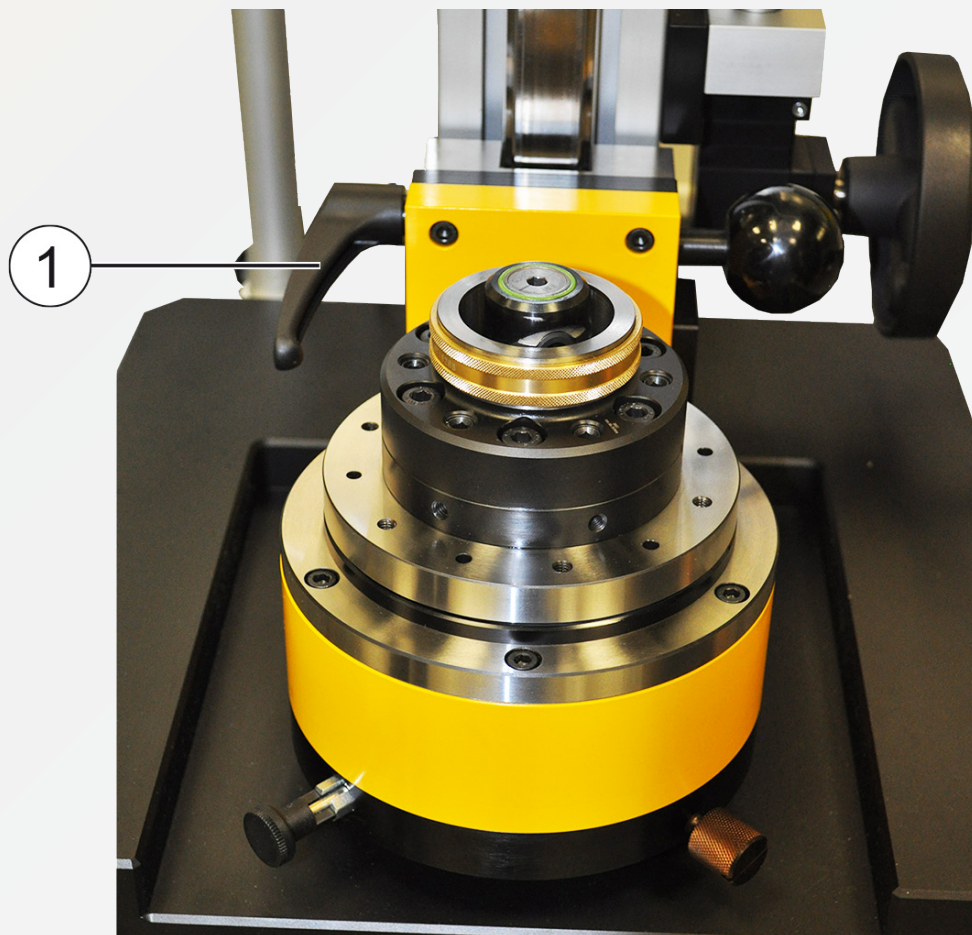

Fig. 32: Set height of spindle

3. Re-tighten the clamping (1).



4. Loosen the locking screws at the measuring sensors (1) and move it to the exterior in horizontal direction to insert the tool into the holder support.

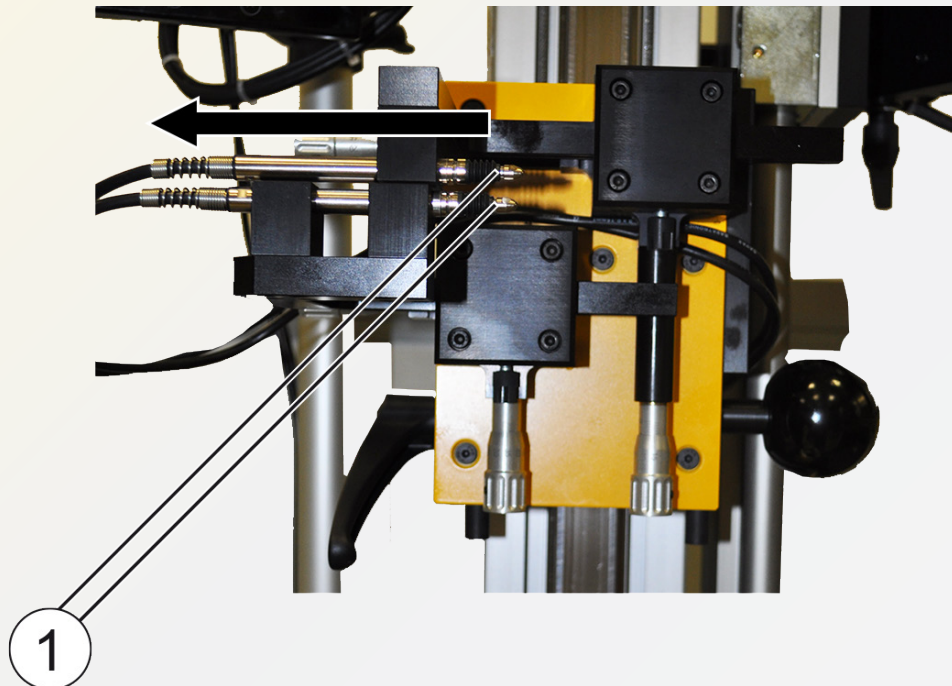

Fig. 33: Move measuring sensor

5. Insert the tool into the spindle and/or between the tips. There are two ways of proceeding:  
**HSK spindle:**
  - I. Move the centring slide upwards and insert the tool into the HSK spindle holder.

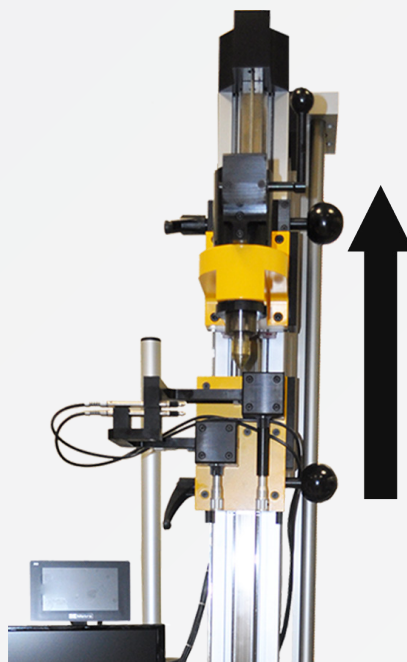

Fig. 34: Move centring slide upwards



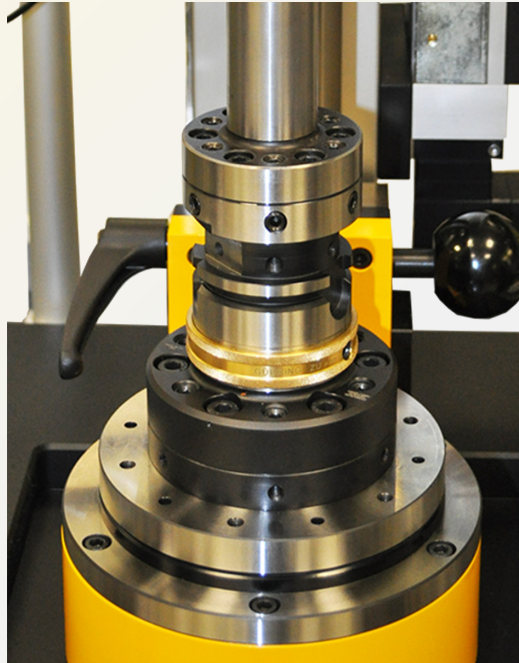

Fig. 35: Insert tool into HSK spindle holder

- II. Tighten the tool inside the spindle by means of a torque wrench (18 Nm with HSK 63).

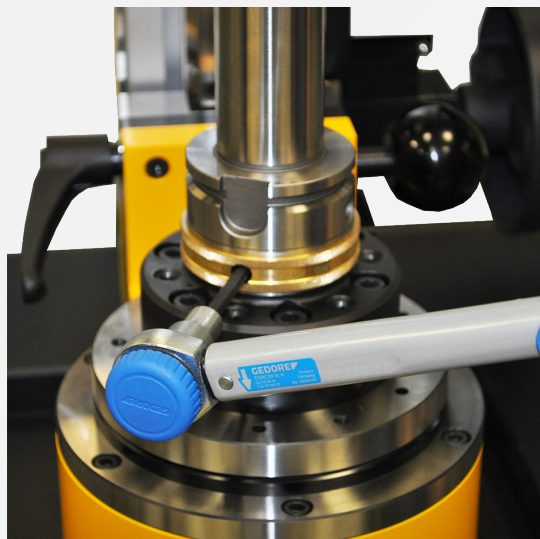

Fig. 36: Tighten tool

**Optional: Straighten bent with centring slide (in case the tool has not been adjusted properly on the module adapter):**

When tightening the tool, use an analogue approach as for the „HSK spindle“ (see page 56).

1. Take the handle (2) into your right hand. Now open the lever (4) with the left hand.
  - ▶ The vertical height adjustment of the measuring slide has now been loosened.



2. Slowly move the measuring slide downwards until the centring tip (3) touches the centre of the tool.
  3. Now pull the lever (1) downwards to slightly lift the centring tip and move the measuring slide downwards until the centring tip touches the tool. The lever (4) is now closed.
- ✓ The tool is now clamped in between the centring tip and the HSK 63 spindle with pretension.

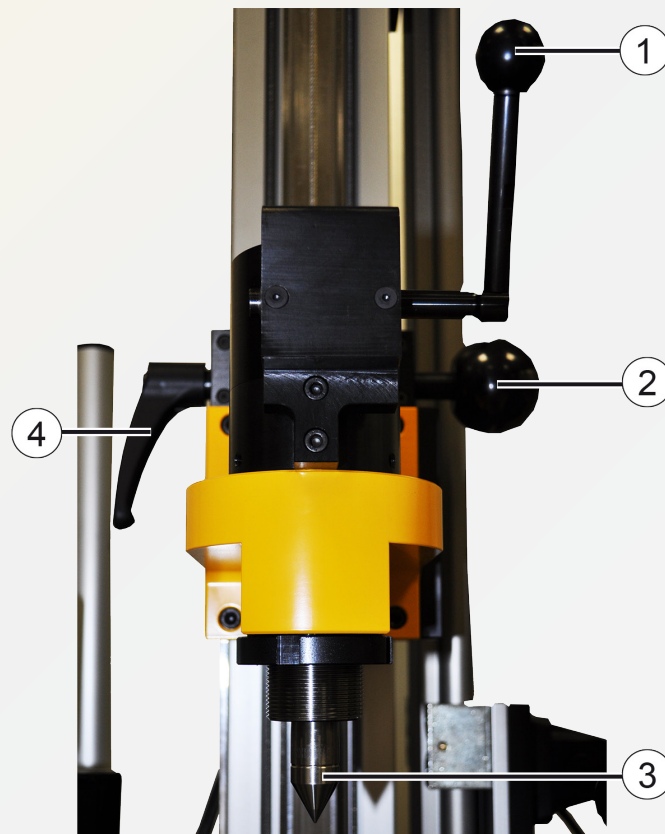

Fig. 37: Lift centring tip



## Clamping between tips or inside spindle with heel:

- I. Insert the optional HSK 63 adapter with tip inside the HSK 63 spindle and tighten it by means of a torque wrench (18 Nm with HSK-63).

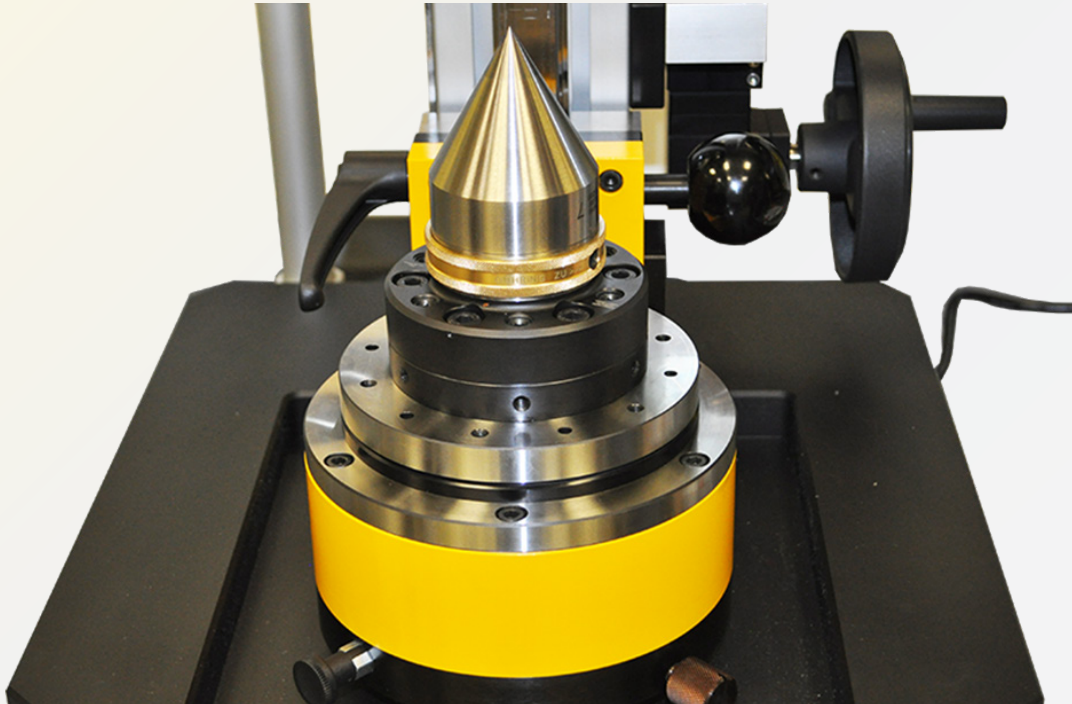

Fig. 38: Insert optional HSK-63 adapter with tip

- II. Estimate/measure the total distance of tool starting from HSK contact surface to tip.



III. Move the centring slide slightly below the expected tip of the tool and tighten it.

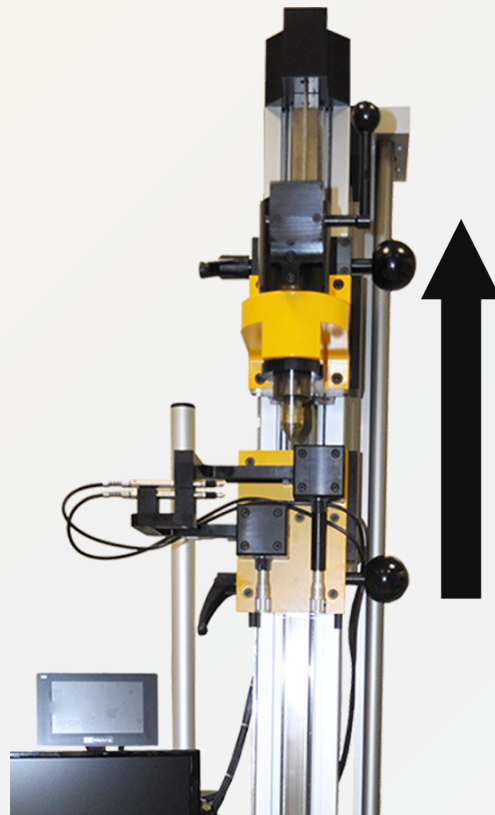

Fig. 39: Move centring slide



Fig. 40: Rough adjustment of centring slide



IV. Lift the centring tip (2) by means of the lever (1) and place the tool between the optional HSK 63 adapter with tip and centring tip.



Fig. 41: Lift centring tip

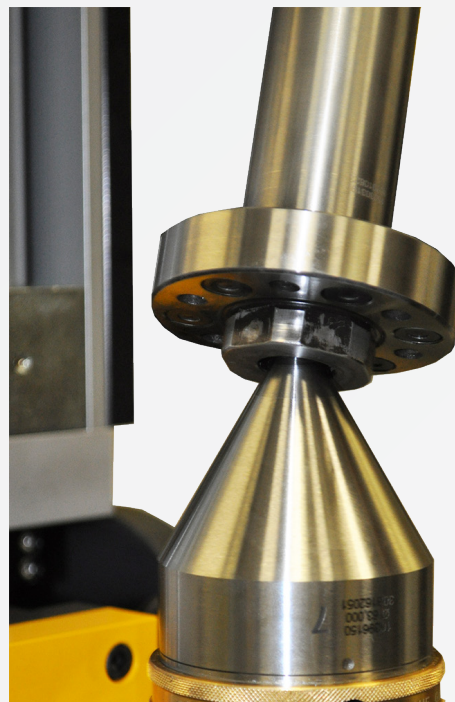

Fig. 42: Insert tool at the bottom



Fig. 43: Insert tool at the top

- IV. Clamp the tool by lowering the centring tip.
  - ✓ The tool is clamped.

## 9.6 Prepare setting



### Setting process

The following describes as an example the setting procedure on a radial (regarding diameter and tapering) as well as axial adjustable PKD tool with 5 guiding rails.

Before making the setting, the adjusting unit needs to be prepared

To prepare the adjusting unit for setting, proceed as follows:

1. Adjust the guiding carriage vertically and the measuring sensor horizontally. Make sure that the sensors on the tool do not touch and that the compound slide is in central position.

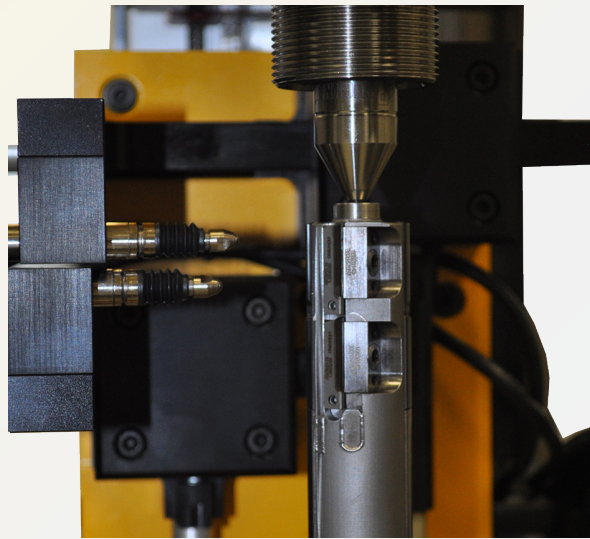

Fig. 44: Adjust guiding carriage

2. Move the guiding carriage in vertical direction to the height of the first guiding rail.
3. Turn the cutting edges in a way that the measuring probes are positioned in parallel to them.

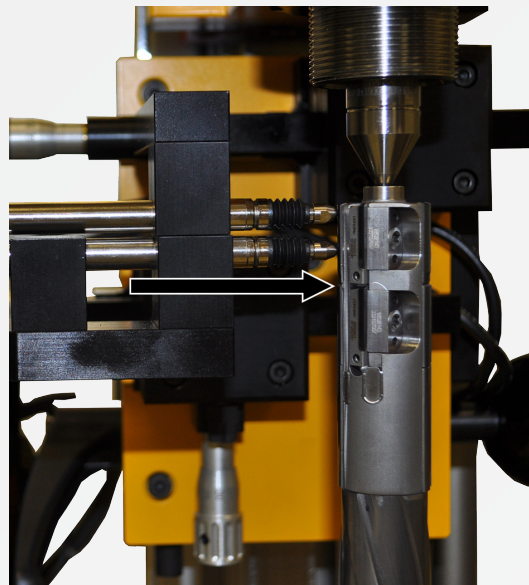

Fig. 45: Roughly adjust measuring slide

4. Move the two measuring probes via the coarse adjustment. Tighten the locking screws when the measuring sensors are approx. 2 mm in front of the tool edge.
5. Adjust the measuring probes vertically by means of the fine adjustment on the compound slide. Position the upper measuring probe as close as possible to the cutting side (<1 mm) To measure tapering position the lower measuring sensor between 10 and 11 mm below or in accordance with the drawings.



Fig. 46: Adjust measuring slide

6. Check the distance with a calliper or a metal rule.  
✓ Setting preparations are completed.

## 9.6.1 Preparing radial cutting setting (diameter setting)

To prepare the adjusting unit, proceed as follows:

1. Determine the setting or guiding rail following the rotating direction of the cutting edge.
2. Position the measuring probe on this rail.
3. For the diameter setting position the measuring probe in horizontal direction with the fine adjustment on the compound slide until it touches the highest point of the guiding rail with a pretension of at least  $150 \mu\text{m}$ . To find the highest point of the guiding rail, the tool must be minimally rotated while being in its clamping.

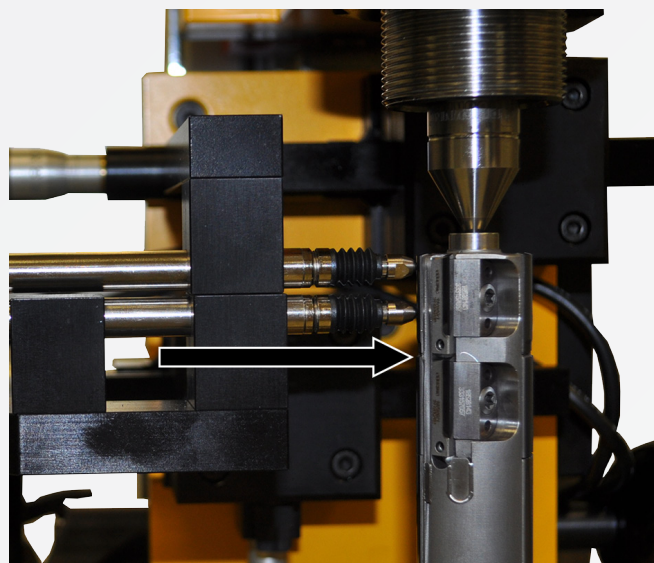

Fig. 47: Apply measuring probe





4. Reset measuring sensor 1.



Fig. 48: Reset measuring sensor

- ✓ Setting of reference dimensions for the upper measuring probe is completed.

## 9.6.2 Preparing radial cutting setting (setting of tapering)

To prepare the adjusting unit for the tapering setting, proceed as follows:

1. Move the lower measuring probe with the fine adjustment of the compound slide in horizontal direction until it touches the guiding rail.

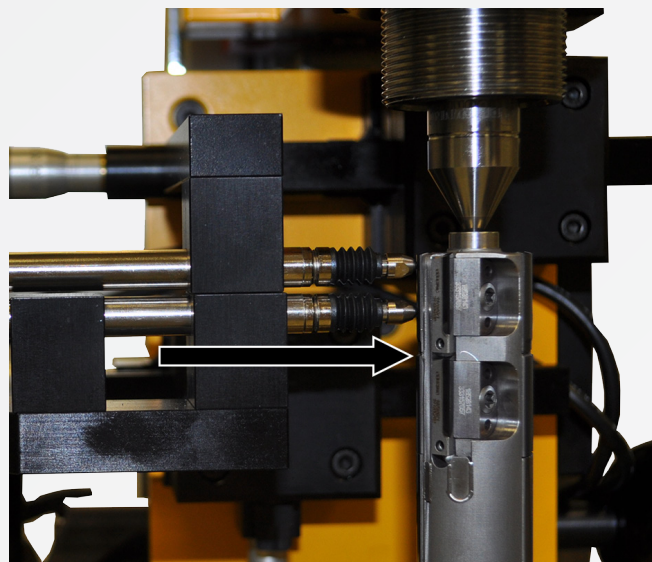

Fig. 49: Position measuring probe



2. Proceed as described above, with a pretension of at least 150  $\mu\text{m}$ . Reset the measuring probe



Fig. 50: Reset measuring probe

- ✓ Setting of reference dimension for the lower measuring probe is completed.

### 9.6.3 Final-preparation

To finally prepare the adjusting unit for setting, proceed as follows:

1. Gauge all guiding rails with the reset measuring probe.
  2. Turn the tool opposite to the cutting direction via the first guiding rail to the cutting edge.
  3. Set the cutting edge radially to approx. 40 $\mu\text{m}$  via the two adjustments at the diameter and the tapering on the tool.
  4. Move the measuring sensor horizontally away from the cutting side and the guiding rail.
- ✓ Preparation is completed and the tool setting can be started.

### 9.7 Setting of axial side clearance of cutting edge (only on EV-800 Plus versions)

To set the axial side clearance of the cutting edge, proceed as follows:

1. Move the camera wing over the vertical, lateral guiding rail at the height of the cutting edge.
2. Position the LED light on the tool and the required point of focus.
3. Place the red cross lines on the upper end of the reference rail.

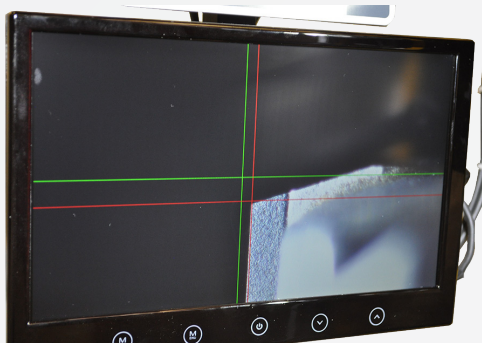

Fig. 51: Adjust red cross lines



4. Calculate the radial adjustment way RV using the following formula:  
 $RV = (FL - VB) / 2$   
GR =  $\emptyset$  of guiding rails actual (usually engraved, if not, measure on an absolute measuring instrument)  
PM =  $\emptyset$  of pre-machining. In this illustration the radial adjustment way is more or less like the distance between the green to the red cross line (approx. 0.1 mm).
5. Turn the tool until the cutting edge on the display appears in focus.

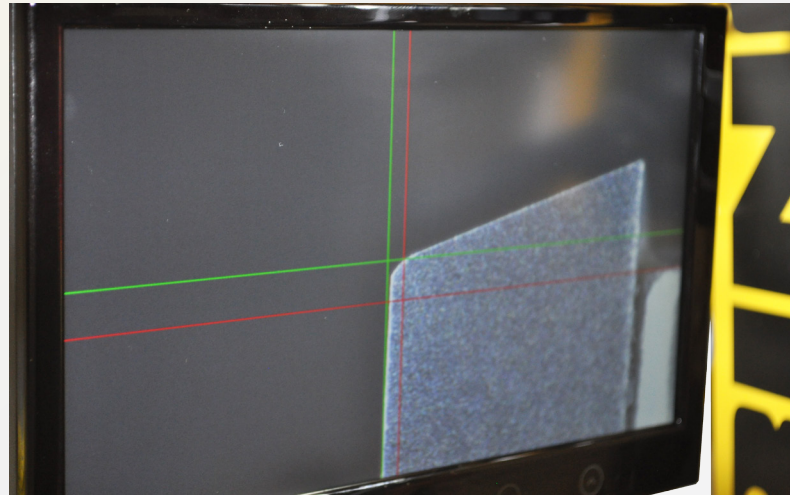

Fig. 52: Cutting edge of tool appears in focus

6. Set the cutting edge of the tool above the axial adjusting screw to the axial final position. Please make sure that the axial side clearance of the cutting edge to the guiding rail is larger than the feed per tooth. The axial distance from the green to the red cross lines on the illustration is approx. 0.2 mm.
  - ✓ The setting of the axial side clearance of the cutting edge is completed.

## 9.8 Radial setting of cutting edge (diameter setting)



### Measuring probe and measuring tips

In addition to the supplied measuring probes any analog and digital measuring sensor with a clamping shank  $\emptyset 8h6$  can be installed in the clamping elements.

To do so, loosen the clamping screw of the clamping elements and replace the probes installed.

Basically the measuring tips can be replaced. Therefore, Gühring offers a wear-resistant measuring tip with PKD equipment. Please also pay attention to the accessories.

Additional or needed accessory and deflectors are available in specialist shops.

To make the radial setting of the cutting edge (diameter setting), please proceed as follows.

1. Turn the tool against cutting direction until the measuring probe touches the tool. To identify the highest point of the cutting edge the tool needs to be slightly rotated.



2. Check if the measuring probes are in the same position as described in chapter „9.6 Preparing setting“.

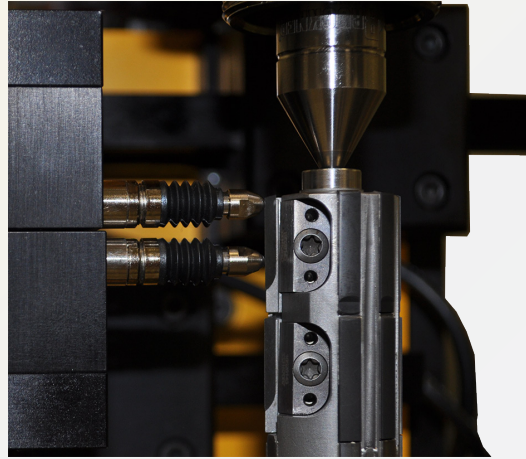

Fig. 53: Apply measuring sensor to cutting edge of tool

3. Set the radial adjustment of the tool cutting edge to approx.  $-30\ \mu\text{m}$  by means of the upper and lower radial adjusting screw.
4. Tighten the clamping claw with the provided torque wrench.
5. Set the radial dimension required by means of the upper radial setting screw.  
(Diameter dimension)



Fig. 54: Set upper radial adjusting screw



6. Use the lower radial adjusting screw to set the required tapering)



Fig. 55: Set lower radial adjusting screw

7. Move the measuring probe away in horizontal direction by means of the upper and lower fine adjustment.

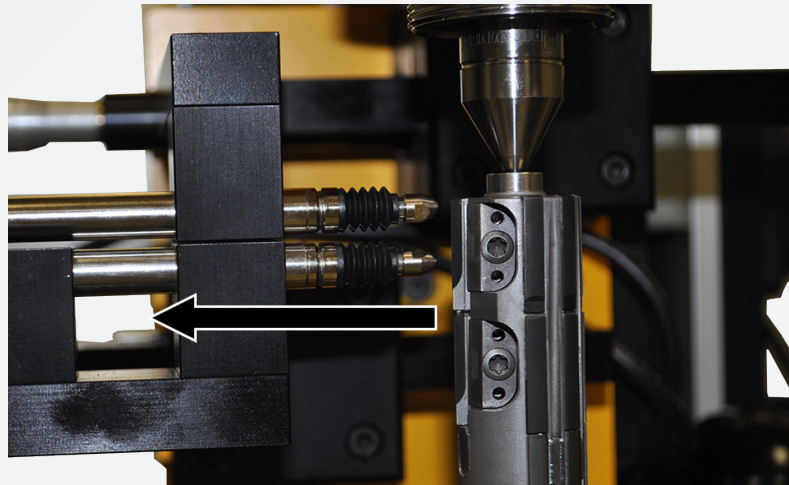

Fig. 56: Move measuring probe away from cutting edge of tool

- ✓ The radial setting of the cutting edge (diameter setting) is completed.



## 9.9 Inspection of axial side clearance of cutting edge

To check the axial side clearance of the cutting edge, proceed as follows:

1. Turn the tool until the cutting edge of the tool is in focus on the display.

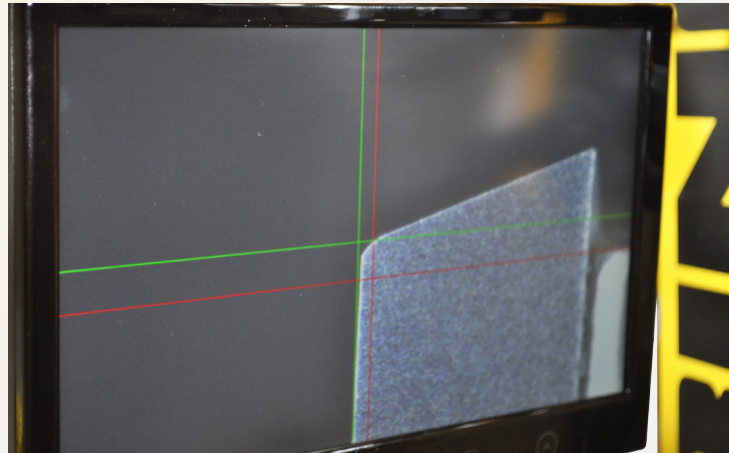

Fig. 57: Cutting edge of tool in focus

- ▶ If the camera has been adjusted, steps 1-6 in chapter „Setting of axial side clearance of cutting edge“ need to be repeated.
- 2. Use the cross lines to check if the axial side clearance of the cutting edge is still within the permissible tolerance.
- 3. If the required values have not been reached, the chapters „Preparing measurement“ to „Inspection of axial side clearance of cutting edge“ subchapters included need to be reviewed. Please make sure that the adjusting screws are reset to the minimum position.
- ✓ Inspection of the axial side clearance of the cutting edge is completed.

## 9.10 Remove tool

To remove the tool from the adjusting unit, proceed as follows:

1. Loosen the locking screws of the coarse adjustment on the compound slide.
2. Move the measuring probes away from tool in horizontal direction. No measuring probe, cutting edges or adjusting and guiding rails can be damaged.

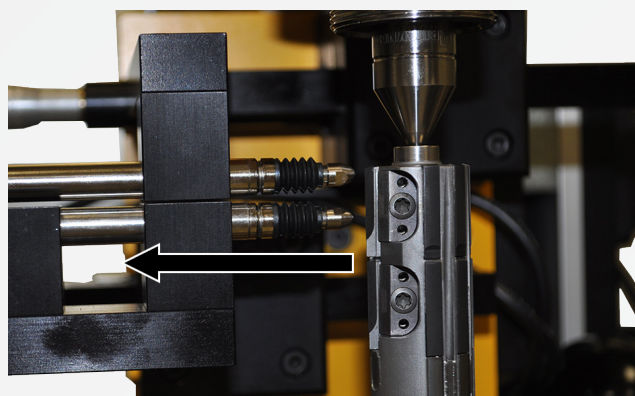

Fig. 58: Move measuring probe away from cutting edge of tool



3. Slightly re-tighten the locking screws.
4. Remove the tool. There are two ways to proceed

**HSK-Spindle:**

- I. If need be, loosen the clamping unit of the centring slide and move it upwards. Then, re-clamp the slide.
- II. Loosen the HSK clamping in the lower spindle.

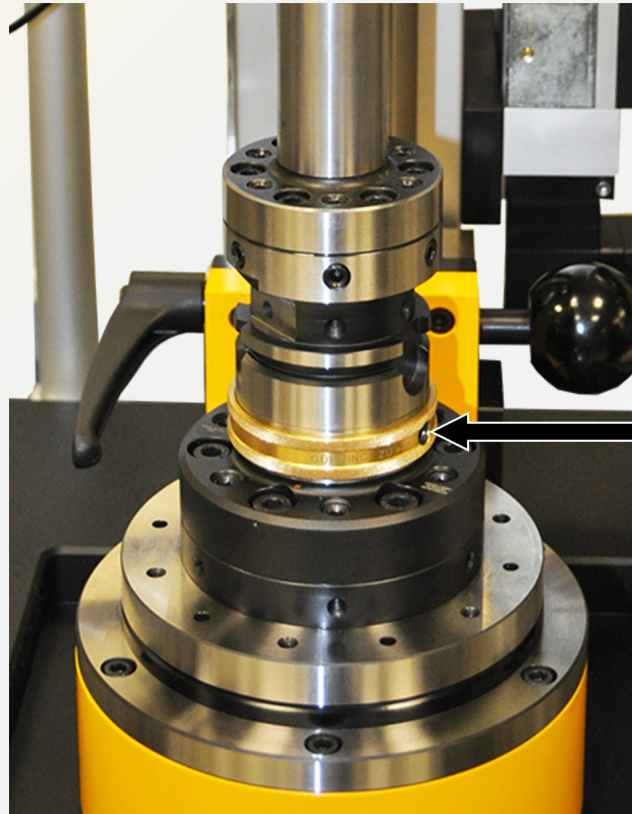

Fig. 59: Loosen HSK clamping

- ✓ The tool is loose and can be removed.



## Clamping between tips or inside spindle with heel:

- I. Hold the tool.
- II. Lift the centring tip (2) above the lever (1).



Fig. 60: Lift centring tip

- ✓ The tool is loose and can be removed.





## 10 Maintenance and servicing



### Staff qualification

The following staff is authorised for „Maintenance and servicing“:

- Staff with relevant professional experience and specialised skills in operating the unit
- All electrical works around the device must only be done by trained, qualified and authorised qualified electricians.



### Important information for your safety

It lies in your responsibility!

In any case the safety instructions in chapter „Basic safety instructions“ and the local safety regulations must be observed and followed.



### Important information on maintenance and servicing

All maintenance and servicing works, as well as repair works within the warranty period need to be carried out by Guhring in order to maintain warranty claim.

All further maintenance and servicing works, as well as repair works are recommended to be carried out by Guhring. Only servicing that is carried out by qualified staff can guarantee safe operation and long tool life period.

## RISK



### Danger in working on live unit parts

When running works on the unit, you might touch parts which carry dangerous voltages during operation. Touching live parts may cause death.

- Works on electrical plants/operating funds of the unit must only be run by qualified electricians or persons who have been instructed if they are under the authority and observance of a qualified electrician in accordance with the electrotechnical regulations
- The safety regulations for running works on electrical plants and operating funds must be observed

## NOTE



### Note on possible property damage due to insufficient maintenance

Insufficient maintenance and servicing can cause damage or dirt, which considerably shortens the operating life of the unit.

Avoid that by cleaning and maintaining the unit properly and on a regular basis.



## 10.1 Measures taken before maintenance and servicing works

Secure the area where maintenance and servicing works are carried out und inform the operating staff.



### Safe separation from electrical power supply system before maintenance and servicing works

When working on the unit, electrical power needs to be switched off. Disconnect mains plug / USB cable as described in chapter „9.3 Switching off“. To protect the unit against being switched on again place the plug in line of sight.

## 10.2 Measures taken after maintenance and servicing works

Check all safety units on proper function and smooth functional process before switching the unit on again.

Only if inspection is completed, the unit is ready and approved to be operated by the staff.

## 10.3 Instructions on service calls and cycles

The required setting, maintenance, servicing activities, deadlines and instructions on how to exchange components and assemblies are absolutely mandatory.

Before starting works, make sure that all necessary workshop tools and relevant components are available at site.

If defects are noticed during maintenance or cleaning, they need to be immediately removed, or the device must be out of operation until they are repaired and safe working on the device can be guaranteed.

The operator who was in charge of the cleaning and maintenance ensures that all works have been done successfully.



### Important information in the supplier's instructions

Always read the supplier's instructions to plan and run your maintenance works.

## 10.4 Notes on Cleaning

### NOTE



#### Note on possible property damage caused by inappropriate cleaning agents

No liquids should get inside the housing. For cleaning do not use liquid agents, strong detergents or compressed air. In case instructions are ignored, the tool might get damaged.

Only use a humid cloth for cleaning.

Clean the device on a regular basis. To do so, proceed as follows:

3. Switch tool off (see chapter „9.3 Switching off“)
  4. Clean the surface of the device by means of a humid, lint-free cloth
  5. Use an anti-corrosion for live components
- ✓ The cleaning of the device is completed.



## 10.5 Maintenance



### Important information for your safety

It lies in your responsibility!

In any case the safety instructions in chapter „Basic safety instructions“ and the local safety regulations must be observed and followed.



### Important information in the supplier's instructions

Always read the supplier's instructions to plan and run your maintenance works.

Code no.	Activity	Interval
G-01	Check seals of guiding carriages and guiding units. If damaged (e.g. cracks) replace them.	Monthly
G-02	Check concentricity and axial run-out using the Gühring test pins. Tolerance: 5 µm Enter tolerance deviations and new amplitude always in field Comments	Monthly
G-03	Always clean and lubricate the guiding carriage and guiding unit individually. Then check the travelling distance.	Monthly
G-04	Check all connecting cables on mechanical damage. If damaged, replace.	Monthly
G-05	Check centring tip on damage. If centring tip is broken or damaged, replace it.	Monthly
G-06	Oil ground surfaces	Weekly



## 10.6 Template Maintenance plan

Code no. carried out	Comment	Date	Name + Signature
G-01			
G-02			
G-03			
G-04			
G-05			
G-06			



## 10.7 Defects and failures

The following defects and failures can occur while operating the adjusting unit. They can be removed:

Error	Possible cause	Remedy
Tool does not have proper concentricity	Holder is dirty	Thoroughly clean the HSK and tool.
Blurred image	Lens not properly set	Adjust lens
	Lens is dirty	Clean lens
Guiding carriages do not run smoothly	Dirty guiding units	Clean and lubricate guiding units.
	Little lubricant	Lubricate guiding units.

## 11 Disposal



### Staff qualification

The following staff is authorised for „Disposal“:

- Staff with relevant professional experience and specialised skills in operating the unit
- All electrical works around the device must only be done by trained, qualified and authorised qualified electricians.





### Important information for your safety

It lies in your responsibility!

In any case the safety instructions in chapter „Basic safety instructions“ and the local safety regulations must be observed and followed.

### 11.1 Disassembly

 <b>RISK</b>	
	<p><b>Danger in working on live unit parts</b></p> <p>When running works on the unit, you might touch parts which carry dangerous voltages during operation. Touching live parts may cause death.</p> <ul style="list-style-type: none"> <li>➤ Works on electrical plants/operating funds of the unit must only be run by qualified electricians or persons who have been instructed if they are under the authority and observance of a qualified electrician in accordance with the electrotechnical regulations.</li> <li>➤ The safety regulations for running works on electrical plants and operating funds need to be observed</li> </ul>



## 11.2 Proper and environmentally friendly Disposal



### **Important information**

A proper and environmentally-friendly disposal is aimed. When retrofitting or disposing the tool, there could be waste products which need to be disposed. Relevant authorised bodies submit appropriate recommendations.

The recommendations for disposing waste products are based on regulations which were valid at the time and place these instructions were set up. As an operator and user of this unit you are committed to get some information about local regulations regarding disposal and to proceed accordingly.



### **Important information in the supplier's instructions**

Always read the supplier's instructions to ensure a proper and environmentally-friendly disposal.

## 11.3 Disposal facilities

Please check your local disposal facilities.



## IMAGE INDEX

Abb. 1: Identification plate	10
Abb. 2: Circuit diagram LED light / Measuring probe unit	13
Abb. 3: Circuit diagram Touch screen / Camera	14
Abb. 4: EV-800 Basic and EV-800 Komfort	16
Abb. 5: EV-800 Basic Plus and EV-800 Komfort Plus	17
Abb. 6: Delivery	27
Abb. 7: Mounting points (1) for eye bolts	29
Abb. 8: View from bottom: Mounting points (1) for eye bolts	29
Abb. 9: Transport position	32
Abb. 10: Display Measuring system	34
Abb. 11: Operating elements Bearing slide	35
Abb. 12: Operating elements Measuring slide	36
Abb. 13: Operating elements Centring slide	37
Abb. 14: Operating elements Display Camera system	38
Abb. 15: Operating elements Crank handle Camera system	39
Abb. 16: Operating elements Power supply unit	40
Abb. 17: Operating elements Fine adjustment Camera system	41
Abb. 18: Clean guiding units	42
Abb. 19: Completely positioned adjusting unit	43
Abb. 20: Tighten test pin	44
Abb. 21: Insert test pin	47
Abb. 22: Loosen screws	47
Abb. 23: Position dial gauge and reset	48
Abb. 24: Fastening screws (1) or adjusting screws (2)	48
Abb. 25: Apply measuring probe	49
Abb. 26: Tighten adjusting screws	50
Abb. 27: Press mains switch	52
Abb. 28: Start measuring system	52
Abb. 29: LED light, switch on camera and screen	53
Abb. 30: Press mains switch	54
Abb. 31: Adjust camera wing	54
Abb. 32: Set spindle height	55
Abb. 33: Move measuring probe	56
Abb. 34: Move centring slide upwards	56
Abb. 35: Insert tool into HSK spindle holder	57
Abb. 36: Tighten tool	57
Abb. 37: Lift centring tip	58
Abb. 38: Insert optional HSK-63 adapter with tip	59
Abb. 39: Move centring slide	60
Abb. 40: Roughly adjust centring slide	60
Abb. 41: Lift centring tip	61
Abb. 42: Insert tool at bottom	61
Abb. 43: Insert tool at top	62
Abb. 44: Adjust guiding carriage	63
Abb. 45: Roughly adjust measuring slide	63
Abb. 46: Adjust measuring slide	64
Abb. 47: Apply measuring probe	64
Abb. 48: Reset measuring probe	65
Abb. 49: Position measuring probe	65
Abb. 50: Reset measuring probe	66



Abb. 51: Adjust red cross lines	66
Abb. 52: Tool of cutting edge in focus	67
Abb. 53: Apply measuring probe at cutting edge of tool	68
Abb. 54: Set upper radial adjusting screw	68
Abb. 55: Set lower radial adjusting screw	69
Abb. 56: Move measuring probe away from cutting edge of tool	69
Abb. 57: Cutting edge of tool in focus	70
Abb. 58: Move measuring probe away from cutting edge of tool	70
Abb. 59: Loosen HSK clamping	71
Abb. 60: Lift centring tip	72